











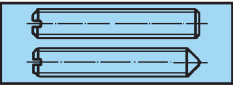











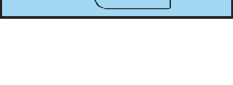

ÖVRIGA ARTIKLAR

SIDA

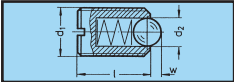
	TSS DIN 417 STÅL OBEH	19:1
	SKSS DIN 438 STÅL OBEH	19:2
	PSS DIN 551 STÅL OBEH	19:3
	SSS DIN 553 STÅL OBEH	19:3
	LÄNKSKRUV LS DIN 444 FORM B STÅL OBEH	19:4
	MFS DIN 963 POLYAMID	19:5
	MCS DIN 84 POLYAMID	19:6
	M6S DIN 933 POLYAMID	19:7
	BRB DIN 125 POLYAMID	19:8
	M6M DIN 555 POLYAMID	19:8
	MHM DIN 1587 POLYAMID	19:8
	T-SPÅRBULT DIN 787	19:9
	RÖRKLAMMER FZB	19:10
	SLANGKLAMMER FZB	19:11
	GUMMIKLAMMER STÅL FZB/ROSTFRI	19:12
	BUNTBAND	19:13
	SMÖRJNIPPLAR	19:14
	FIBERBRICKA	19:15
	FÄSTÖRON	19:16

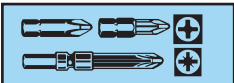
ÖVRIGA ARTIKLAR

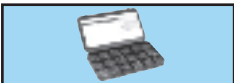
		SIDA
	GUMMIEXPANDER WELL NUT® + BUFFEX	19:17
	FJÄDRANDE TRYCKSKRUV	19:18
	FASTA SKRUVNYCKLAR ENKLA OCH DUBBLA	19:19
	BITSHÅLLARE OCH BITS	19:20
	VERKTYGSHÅLLARE SLUTEN OCH ÖPPEN	19:21
	SORTIMENTLÅDA	19:22, 19:23, 19:24

TSS

DIN 417
STÅL OBEH

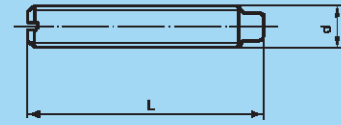

d	M3	M4	M5	M6	M8	M10	M12	M16
L	PRIS KRONOR PER 100 ST.							
5	189	189						
6	189	189	216	242	320			
8	189	192	219	242	309			
10	192	197	225	246	327	531		
12	207	197	228	260	350	558	990	
16	237	219	242	275	395	608	1070	
18	252	243	284	309	428	687	1125	
20	261	260	297	320	467	765	1238	2633
22	270	266	306	347	494	810	1328	2813
25	270	297	318	365	518	855	1328	2813
30	315	350	374	426	620	935	1575	2970
35		392	450	473	675	990	1688	3150
40		450	521	575	732	1115	1913	3285
45				653	845	1193	2160	3623
50				720	945	1305	2430	3983
55					1148	1350	2723	4320
60					1328	1575	2993	4658
BEST.EX: TSS STÅL M3 x 5 OBEH DATA.EX: 41703005								

FÖRPACKNINGAR

ST	M3	M4	M5	M6	M8	M10	M12	M16
100	5-30	5-40	6-40	6-50	6-60			
50						10-60	12-60	20-60

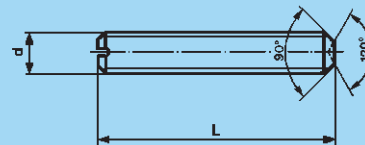

d	M3	M4	M5	M6	M8	M10
L	PRIS KRONOR PER 100 ST.					
3	189					
4	189	198				
5	189	189	215			
6	189	189	216	242		
8	189	192	219	242	309	
10	192	197	225	246	327	467
12	207	197	228	260	350	494
16	237	219	242	275	395	
18		243		320		
20		260	297	320	467	
25		297	318	365	518	
30				426	620	867
BEST.EX: SKSS STÅL M3 x 3 OBEH DATA.EX: 43803003						

FÖRPACKNINGAR

ST	M3	M4	M5	M6	M8	M10
100	3-16	4-25	5-25	6-30	8-30	10-30

PSS, SSS

DIN 551, DIN 553 (ISO 4766, ISO 7434)
STÅL OBEH

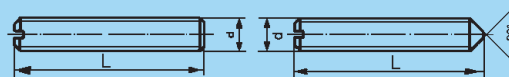

d	M1,4	M1,6	M2	M2,5	M3	M4	M5	M6	M8	M10
L	PRIS KRONOR PER 100 ST.									
2	279	260								
3	279	260	176	201	129	158				
4	279	261	180	201	129	140	183	203		
5	284	270	201	206	129	131	153	185	284	
6	293	284	210	219	129	135	156	176	284	419
8	309	300	219	233	129	135	158	176	273	419
10		327	233	246	131	138	165	183		419
12				260	144	144	167	192	269	431
16				275	185	167	180	206	306	476
18					197	197	233	251	374	539
20					206	210	242	246	368	597
22					246	246	248	284	431	630
25					246	246	257	284	413	675
30					257	287	306	374	522	743
35						345	392	413	563	788
40						395	450	503	620	890
45								563	698	980
50								620	800	1070
60								1125	1125	1260
70									1395	1620
80									1688	1980
BEST.EX: PSS STÅL M1,4 x 2 OBEH DATA.EX: 551014002										

FÖRPACKNINGAR

ST	M1,4	M1,6	M2	M2,5	M3	M4	M5	M6	M8	M10
200			3-10	3-16	3-30	3-30	4-30	4-22		
100	2-8	2-10				35-40	35-40	25-60	5-80	6-80

LÄNKSKRUV

DIN 444 FORM B
STÅL 4.6 OBEH

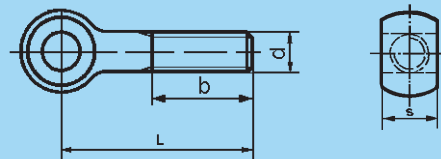

d	M5	M6	M8	M10	M12	M16	M20	M24	M30
b*	16	18	22/28	26/32	30/36	38/44	46/52	54/60	66/72
s	6	7	9	12	14	17	22	25	30
L	PRIS KRONOR PER 100 ST.								
25	6300	6300	7088	7988	13163				
30	6300	6300	7088	7988	8775				
35	5738	5738	7200	8100	9000				
40	5738	5738	7425	8438	9000	15075			
45		6300	7538	8550	9450	15075			
50		6300	7538	8550	10238	15075			
55		6750	7650	8888	10688	15075			
60		6750	7650	13332	10688	15075			
65		7988	7988	9113	10800	15525			
70		7988	7988	9113	10800	15525			
75		9225	8213	9338	10800	16200			
80		9225	8213	9338	10800	16200	21600	30825	
90			8438	9788	10913	16875	22275	31950	
100			8888	9788	12375	16875	34763	33525	
110			10125	10238	12600	17550	24075	35325	
120			10800	16032	13500	18225	24750	36900	72000
130			11475	11138	14625	18450	25425	38700	73125
140			11925	11925	15525	18900	26325	40500	75250
150					16875	19575	27900	42525	75375
160					19350	20250	28575	44325	77625
170					19800	20700	30150	46575	81000
180					20250	21375	30825	49050	84375
190					21375	22275	31950	52650	87750
200					21825	23175	32175	54000	91125
* AVSER GÄNGLÄNGDER FÖR L=25-125 RESPEKTIVE GÄNGLÄNGDER FÖR L=130-200									
BEST.EX: LS STÅL DIN 444B M5 x 25									
DATA.EX: 444B05025									

FÖRPACKNINGAR

ST	M5	M6	M8	M10	M12	M16	M20	M24	M30
50	25-40	25-40	25-35	25-35					
25		45-80	40-140	40-110	25-45				
10				120-140	50-140	40-120			
LÖSA					150-200	130-200	80-200	80-200	120-200

MFS

**DIN 963 (SS 2393)
POLYAMID**

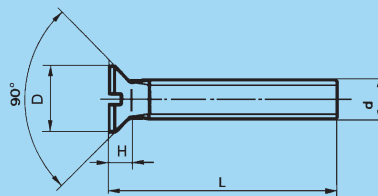

d	M3	M4	M5	M6	M8	M10
D	5,6	7,5	9,2	11	14,5	18
H	1,65	2,2	2,5	3	4	5
L	PRIS KRONOR PER 100 ST.					
6	338	360				
8	323	387	426			
10	333	399	426	486		
12	347	413	441			
16	354	419	512	554	1040	
20	377	441	545	617	1112	
25	404	467	585	687	1160	2136
30	437	486	629	759	1317	2331
35		521	671	813	1449	
40			710	945	1521	
45				977		
50				993	1701	2907
60				1049	1899	
70					2048	

BEST.EX: MFS POLYAMID M3 x 6
DATA.EX: 963P03006

ST	M3	M4	M5	M6	M8	M10
100	6-30	6-35	8-40	10-60	16-70	25-50

MCS

**DIN 84 (SS 2167)
POLYAMID**

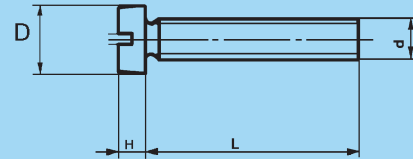

d	M3	M4	M5	M6	M8	M10
D	5,5	7	8,5	10	13	16
H	2	2,6	3,3	3,9	5	6
L	PRIS KRONOR PER 100 ST.					
3	354					
4	354					
5				450		
6	320	347	399	460		
8	333	359	404	471		
10	347	367	401	459	945	
12	347	377	408	446		
16	354	392	426	491	1034	
18	392	399				
20	377	387	549	531	1128	2105
25	404	426	561	611	1197	2268
30	417	450	606	743	1292	2483
35		480	644	782	1349	2663
40		494	680	813	1412	2876
45				836		2993
50			759	860	1512	3087
60				908	1931	3308
70				962	2136	3402
80					2285	
BEST.EX: MCS POLYAMID M3 x 3						
DATA.EX: 84P03003						

ST	M3	M4	M5	M6	M8	M10
100	3-30	6-40	6-50	5-70	10-80	20-70

M6S

DIN 933 (SS 2165)
POLYAMID

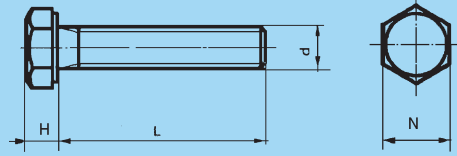

d	M4	M5	M6	M8	M10	M12	M16
D	7	8	10	13	17	19	24
H	2,8	3,5	4	5,5	7	8	10
L	PRIS KRONOR PER 100 ST.						
6	347	399	590	790			
8	359	408	538				
10	372	419	467	945			
12	377	426	498				
16	392	471	498	1034			
20	408	549	561	1128	2105	2457	
25	426	561	611	1197	2268	2979	
30	450	606	743	1292	2483	3119	
35		644	782	1349	2672	3261	
40	494	680	813	1412	2750	3261	
45			836		2993	3576	
50		759	860	1443	3087	3749	5529
55					3198		6096
60			908	1931	3308	4064	6426
70			962	2136	3402	4379	8316
75			993				
80				2294	3528	4679	
90							10065
BEST.EX: M6S POLYAMID M4 x 6							
DATA.EX: 933P04006							

ST	M4	M5	M6	M8	M10	M12	M16
100	6-40	6-50	6-75	6-80	20-80	20-80	50-90

BRB

DIN 125 (SS 70)
POLYAMID

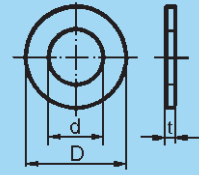

FÖR SKRUV	d	D	t	FÖRPACKNINGAR	PRIS KRONOR PER 100 ST.
M2	2,2	5	0,3	1000	45
M2,5	2,7	6	0,5	1000	45
M3	3,2	7	0,5	1000	47
M3,5	3,7	8	0,5	1000	62
M4	4,3	9	0,8	1000	62
M5	5,3	10	1	1000	90
M6	6,4	12	1,6	1000	137
M8-5/16	8,4	16	1,6	1000	189
M10	10,5	20	2	500	306
M12	13	24	2,5	100	530
M16-5/8	17	30	3	100	638
M20	21	37	3	100	1140

BEST.EX: BRB POLYAMID 2,7
DATA.EX: 125P027

M6M

DIN 555 (SS 2175)
POLYAMID

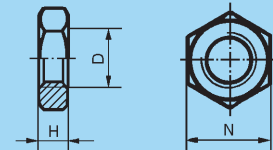

D	N	H	FÖRPACKNINGAR	PRIS KRONOR PER 100 ST.
M3	5,5	2,4	100	314
M4	7	3,2	100	342
M5	8	4	100	392
M6	10	5	100	419
M8	13	6,5	100	630
M10	17	8	100	1134
M12	19	10	100	1364
M16	24	13	100	2483

BEST.EX: M6M POLYAMID M3
DATA.EX: 555P03

MHM

DIN 1587 (SS 2180)
POLYAMID

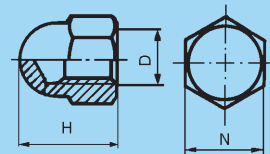

D	N	H	FÖRPACKNINGAR	PRIS KRONOR PER 100 ST.
M3	5,5	6,3	100	539
M4	7	8	100	603
M5	8	10	100	729
M6	10	12	100	755
M8	13	15	100	1119
M10	17	18	100	1884
M12	19	22	100	2231
M16	24	28	100	3969

BEST.EX: MHM POLYAMID M3
DATA.EX: 1587P03

T-SPÅRBULT

INKL. MUTTER OCH BRICKA
DIN 787
STÅL 8.8

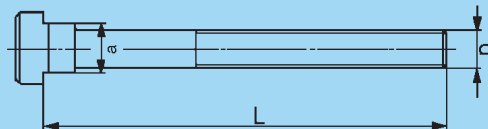

SPÅRBREDD a	DIMENSION d	LÄNGD	PRIS KRONOR PER 100 ST.
6	M6	25	23175
6	M6	40	23175
6	M6	63	24975
8	M8	32	24975
8	M8	50	25425
8	M8	80	26550
10	M10	40	23625
10	M10	63	25425
10	M10	100	26550
12	M12	50	25425
12	M12	63	26100
12	M12	80	27000
12	M12	125	29700
12	M12	200	35550
14	M12	50	26100
14	M12	80	27450
14	M12	125	31275
14	M12	200	36000
16	M14	63	32625
16	M14	100	36450
16	M14	160	44325
16	M14	250	51525
16	M16	63	35550
16	M16	80	36450
16	M16	100	38700
16	M16	160	43875
16	M16	200	48600
16	M16	250	51150
18	M16	63	37800
18	M16	80	38700
18	M16	100	39600
18	M16	160	45450
18	M16	200	48600
18	M16	250	53325
20	M20	80	55800
20	M20	125	58050
20	M20	160	60075
20	M20	200	67950
20	M20	315	79425
22	M20	80	57150
22	M20	100	59175
22	M20	125	60525
22	M20	160	64350
22	M20	200	72225

FÖRPACKNINGAR: ENLIGT ÖNSKEMÅL

BEST.EX: T-SPÅRBULT 6 M6 x 25

DATA.EX: 7870606025

RÖRKLAMMER

MED KRAFTIG KRAMPA
STÅL FÖRZINKAD



DIAMETER	GÄNGA	FÖRP.	ART NR	PRIS KRONOR PER 100 ST.
25 mm	M8	10	58232025	2543
28 mm	M8	10	58232028	2635
32 mm	M8	10	58232032	1647
35 mm	M8	10	58232035	1719
38 mm	M8	10	58232038	1755
42 mm	M8	10	58232042	1751
45 mm	M8	10	58232045	1814
48 mm	M8	10	58232048	2016
51 mm	M8	10	58232051	2093
54 mm	M8	10	58232054	2201
57 mm	M8	10	58232057	2205
60 mm	M8	10	58232060	2318
64 mm	M8	10	58232064	2430
67 mm	M8	10	58232067	2633
70 mm	M8	10	58232070	2745
73 mm	M8	10	58232073	2835
76 mm	M8	10	58232076	2970
83 mm	M8	10	58232083	4995
89 mm	M8	10	58232089	5400
95 mm	M8	10	58232095	5715
102 mm	M8	10	58232102	5895

BEST.EX: RÖRKLAMMER 582 32025 25 MM FZB
DATA.EX: 58232025

SLANGKLAMMER

BANDJÄRN FÖRZINKAD

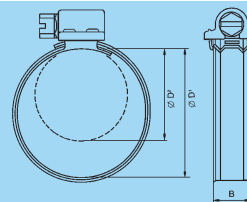

SPÄNNOMRÅDE Ø	BREDD MM	FÖRPACKNINGAR	PRIS KRONOR PER 100 ST.
11-17	9	50	1850
13-20	9	50	1904
15-24	12	50	1904
19-28	12	50	1904
22-32	12	50	2120
26-38	12	50	2120
32-44	12	50	2120
38-50	12	50	2295
44-56	12	50	2295
50-65	12	50	2538
58-75	12	50	2741
68-85	12	50	3051
77-95	12	50	3227
87-112	12	50	3456
104-138	12	50	3752
130-165	12	50	4307
150-180	12	50	5022
175-205	12	50	5522
200-231	12	50	6102
226-256	12	25	6750
251-282	12	25	7425
277-307	12	25	8033

BEST.EX: SLANGKLAMMER 11-17
DATA.EX: SLANG1117

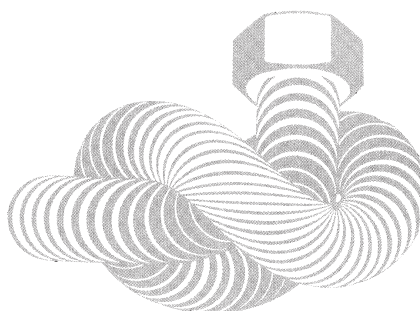

GUMMIKLAMMER

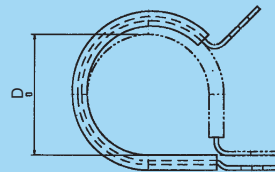

STÅL FZB/ROSTFRI 2333 (A2)

D	FÖRP.	STÅL FZB		ROSTFRI	
		VÅRT ART.NR.	PRIS KRONOR PER 100 ST.	VÅRT ART.NR.	PRIS KRONOR PER 100 ST.
3 MM	100	GUM003	780	GUMA2003	2655
5 MM	100	GUM005	810	GUMA2005	2925
6 MM	100	GUM006	860	GUMA2006	3090
8 MM	100	GUM008	870	GUMA2008	3120
10 MM	100	GUM010	900	GUMA2010	3150
11 MM	100	GUM011	980	GUMA2011	3240
13 MM	100	GUM013	1110	GUMA2013	3600
14 MM	100	GUM014	1170	GUMA2014	3720
16 MM	100	GUM016	1220	GUMA2016	5738
18 MM	50	GUM018	1350	GUMA2018	3945
19 MM	50	GUM019	1460	GUMA2019	4215
21 MM	50	GUM021	1520		
22 MM	50	GUM022	1580	GUMA2022	4394
24 MM	50	GUM024	1650		
25 MM	50	GUM025	1740	GUMA2025	6930
27 MM	50	GUM027	1920		
29 MM	50	GUM029	2000	GUMA2029	5070
30 MM	50	GUM030	2030		
32 MM	50	GUM032	3180	GUMA2032	6075
33 MM	50	GUM033	3260		
35 MM	50	GUM035	3320	GUMA2035	6300
36 MM	50	GUM036	3390		
38 MM	50	GUM038	3450	GUMA2038	6525
41 MM	50	GUM041	3980		
45 MM	25	GUM045	4110	GUMA2045	7800
47 MM	25	GUM047	4310		
51 MM	25	GUM051	4530		
54 MM	25	GUM054	4790		
57 MM	25	GUM057	4940		
60 MM	25	GUM060	5090		
63 MM	25	GUM063	5240		
65 MM	25	GUM065	5360		
72 MM	10	GUM072	5660		
74 MM	10	GUM074	5850		
81 MM	10	GUM081	5910		
100 MM	10	GUM100	7280		
110 MM	10	GUM110	7710		

BEST.EX: GUMMIKLAMMER STÅL 3 MM FZB
DATA:EX: GUM003

BEST.EX: GUMMIKLAMMER A2 3 MM
DATA:EX: GUMA2003

BUNTBAND



POLYAMID 6.6

NATUR	SVART	STORLEK	FÖRP.	KARTONG	PRIS PER 100 ST.
CABLE5201	CABLE5301	75x2,2	100	60000	38
CABLE5203	CABLE5303	98x2,5	100	40000	26
CABLE5205	CABLE5305	135x2,5	100	35000	47
CABLE5206	CABLE5306	160x2,6	100	35000	57
CABLE5207	CABLE5307	200x2,6	100	25000	85
CABLE5208	CABLE5308	370x3,6	100	10000	244
CABLE5209	CABLE5309	140x3,6	100	25000	69
CABLE5210	CABLE5310	290x3,6	100	15000	133
CABLE5211	CABLE5311	160x4,5	100	15000	117
CABLE5212	CABLE5312	450x4,5	100	25000	87
CABLE5213	CABLE5313	178x4,8	100	15000	119
CABLE5214	CABLE5314	200x3,6	100	20000	106
CABLE5215	CABLE5315	200x4,8	100	13000	118
CABLE5216	CABLE5316	250x4,8	100	10000	150
CABLE5217	CABLE5317	290x4,8	100	10000	190
CABLE5218	CABLE5318	390x4,8	100	7000	300
CABLE5219	CABLE5319	360x4,8	100	7500	243
CABLE5220	CABLE5320	430x4,8	100	6000	338
CABLE5221	CABLE5321	120x7,8	100	9000	246
CABLE5223	CABLE5323	180x7,8	100	6000	272
CABLE5225	CABLE5325	240x7,8	100	5000	349
CABLE5226	CABLE5326	300x7,8	100	4000	394
CABLE5227	CABLE5327	365x7,8	100	3500	469
CABLE5229	CABLE5329	450x7,8	100	3000	675
CABLE5231	CABLE5331	540x7,8	100	2000	993
CABLE5233	CABLE5333	750x7,8	100	2000	1254
CABLE5234	CABLE5334	780x9,0	100	1300	1435
CABLE5235	CABLE5335	225x12,6	50	2000	825
CABLE5237	CABLE5337	500x12,6	50	1000	1407
CABLE5239	CABLE5339	720x12,6	50	1000	1688
CABLE5241	CABLE5341	850x12,6	50	1500	1494
CABLE5243	CABLE5343	1000x12,6	50	1000	2813

BEST.EX: BUNTBAND 75 x 2,2 NATUR
DATA.EX: CABLE5201

POLYAMID 6.6 – Råmaterial egenskaper

Vattenupptagning	2,5% (50% relativ luftfuktighet)
Arbetstemperatur	-40°C till +85°C
Max och min temperatur	-10°C till +60°C
Peak temperatur	+110°C korta perioder
Smälttemperatur	+256°C
Syre Index	27%
Brandklassning	UL94 klass V2
Genomslagshållfasthet	50.000 volt/mm
Väder resistens	Hög resistens mot Basiska oljor, fetter, kloridlösningar Begränsad resistens mot syror Ingen resistens mot fenoler Halogenfria lösningar

SMÖRJNIPPEL

M-gångor: Koniska enligt DIN 158

R-gångor: Koniska withworth rörgångor enl. SS-ISO 7/1

SAE-gångor: Koniska UNF-gångor

W-gångor: Cylindriska withworth maskingångor.

STÅL FÖRZINKAD

BETECKNING	ART. NR	FÖRP.	GÄNGA	PRIS KR PER 100 ST.	BETECKNING	ART. NR	FÖRP.	GÄNGA	PRIS KR PER 100 ST.
RAK					VINKEL 90 GR.				
509	509	100	R 1/8	642	535	535	100	R 1/8	1223
512	512	100	R 1/4	986	538	538	100	R 1/4	1499
513	513	100	SAE 1/4	540	525	525	100	SAE 1/4	1223
585	585	100	M6 x 0,75	791	589	589	100	M6 x 0,75	1512
504	504	100	M6 x 1	540	576	576	100	M6 x 1	1242
586	586	100	M8 x 0,75	791	590	590	100	M8 x 0,75	1512
505	505	100	M8 x 1	791	577	577	100	M8 x 1	1512
507	507	100	M8 x 1,25	791	514	51490	100	M8 x 1,25	1512
580	580	100	M10 x 1	642	583	583	100	M10 x 1	1223
516	516	100	W1/4	791	516	51690	100	W 1/4	1512
510	510	100	W5/16	1512	517	517	100	W 5/16	2214
511	511	100	W 3/8	1404	518	518	100	W 3/8	2214
506	506	100	M7 x 1	1404					
515	515	100	R 3/8	2795					
VINKEL 45 GR.					RAK				
519	519	100	R 1/8	1223	1698 - 30 MM	1698	100	SAE 1/4	3059
512 B	51245	100	R 1/4	1499	1697 - 30 MM	1697	100	M6 x 1	2039
547	547	100	SAE 1/4	1223					
587	587	100	M6 x 0,75	1512	INSLAG				
560	560	100	M6 x 1	1242	500	500	100	Ø6	642
588	588	100	M8 x 0,75	1512	501	501	100	Ø8	642
505 B	50545	100	M8 x 1	1499					
514 B	51445	100	M8 x 1,25	1499					
584	584	100	M10 x 1	1223					
549	549	100	W 1/4	1512					

BEST.EX: SMÖRJNIPPEL 509 RAK R 1/8

DATA.EX: 509

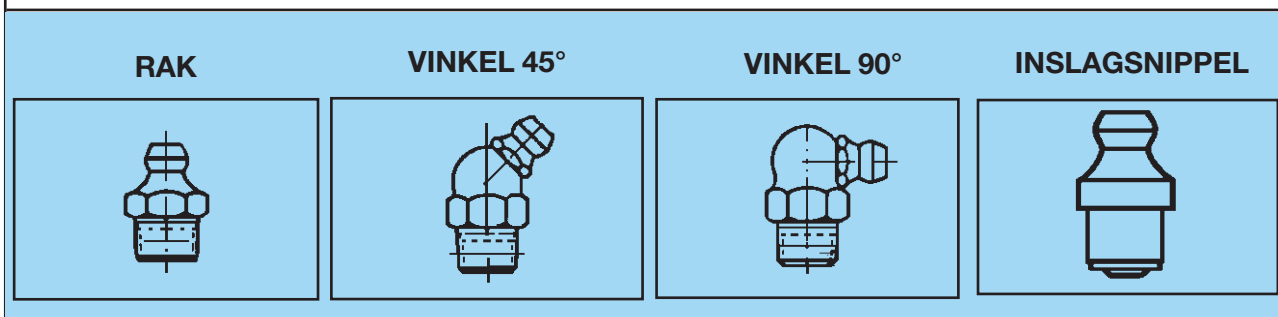

FIBERBRICKA

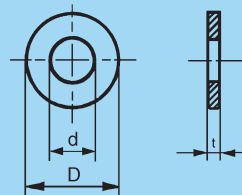

FÖR SKRUV	d	D	t	ART NR	PRIS KRONOR PER 100 ST.
M2	2,7	6,0	1,0	FIB0270610	54
M2	2,8	5,0	0,5	FIB0280505	116
M3	3,0	6,5	1,0	FIB03006510	65
M3	3,1	5,5	1,0	FIB03105510	54
M3	3,2	8,0	1,0	FIB0320810	62
M3	3,5	7,0	0,5	FIB0350705	128
M3	3,5	8,0	1,0	FIB0350810	117
M3	3,7	6,0	1,0	FIB0370610	59
M4	4,0	8,0	1,0	FIB0400810	52
M4	4,1	8,0	1,0	FIB0410810	52
M4	4,5	10,0	1,0	FIB04510010	65
M5	5,0	9,0	1,0	FIB0500910	120
M5	5,0	10,0	1,0	FIB0501010	189
M5	5,3	9,0	1,0	FIB0530910	67
M6	6,0	10,0	1,0	FIB0601010	71
M6	6,0	11,0	1,0	FIB0601110	189
M6	6,0	15,0	1,0	FIB0601510	189
M6	6,5	11,0	1,0	FIB0651110	189
M8	8,0	12,0	1,0	FIB0801210	192
M8	8,0	13,0	1,0	FIB0801310	189
M8	8,0	14,0	1,0	FIB0801410	152
M8	8,1	14,0	1,0	FIB0811410	152
M8	9,0	15,0	1,0	FIB0901510	152
M10	10,0	14,0	1,0	FIB1001410	256
M10	10,0	15,0	1,0	FIB1001510	189
M10	10,0	18,0	1,0	FIB1001810	352
M10	11,0	16,0	1,0	FIB1101610	352
M10	11,5	18,0	1,0	FIB1151810	352
M12	12,0	16,0	1,0	FIB1201610	320
M12	12,0	16,0	1,5	FIB1201615	320
M12	12,7	19,0	1,0	FIB1271910	480
M12	13,0	18,0	1,5	FIB1301815	480
M12	13,0	20,0	1,0	FIB1302010	496
M14	14,0	20,0	1,5	FIB1402015	400
M14	14,5	21,0	1,0	FIB1452110	496
M16	16,0	20,0	1,0	FIB1602010	496
M16	16,0	20,0	1,5	FIB1602015	496
M16	16,0	25,0	1,0	FIB1602510	669
M16	17,0	25,0	1,0	FIB1702510	669
M18	18,0	22,0	1,5	FIB1802215	448
M20	20,0	24,0	1,5	FIB2002415	496
M20	20,0	30,0	1,0	FIB2003010	1690
M20	21,0	31,0	1,0	FIB2103110	1074
M22	23,0	33,0	1,0	FIB2303310	1189
M27	29,0	38,0	1,0	FIB2903810	1507
M33	33,0	42,0	1,0	FIB3304210	1507

BEST.EX: FIBERBRICKA 2,7 x 6 x 1,0

DATA.EX: RWF0270610

FÖRPACKNINGAR

ST	d
1000	2-10
500	11-33

FÄSTÖRON

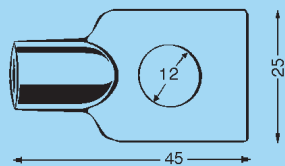

ADUCERAD FÖRZINKAD

BETECKNING	INV.GÄNGA	FÖRPACKNINGAR	PRIS KRONOR PER 100 ST.
BO 25/6	M6	50	3218
BO 25/8	M8	50	3263
BO 25/10	M10	50	3428
BEST.EX: FÄSTÖRON BO 25/6 M6			
DATA.EX: FORON256			

FÄSTÖRON

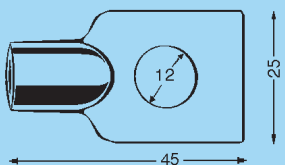

SUBAL FÖRZINKAD

BETECKNING	INV.GÄNGA	FÖRPACKNINGAR	PRIS KRONOR PER 100 ST.
BO 25/6	M6	100	2925
BO 25/8	M8	100	2993
BO 25/10	M10	100	3225
BEST.EX: FÄSTÖRON SUBAL BO 25/6 M6			
DATA.EX: FORONSUBAL256			

FÄSTÖRON

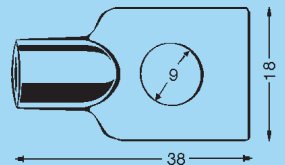

ADUCERAD FÖRZINKAD

BETECKNING	INV.GÄNGA	FÖRPACKNINGAR	PRIS KRONOR PER 100 ST.
BO 18/6	M6	100	2063
BO 18/8	M8	100	2093
BEST.EX: FÄSTÖRON BO 18/6 M6			
DATA.EX: FORON186			

FÄSTÖRON

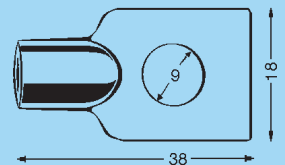

SUBAL FÖRZINKAD

BETECKNING	INV.GÄNGA	FÖRPACKNINGAR	PRIS KRONOR PER 100 ST.
BO 18/6	M6	100	1793
BO 18/8	M8	100	1838
BEST.EX: FÄSTÖRON SUBAL BO 18/6 M6			
DATA.EX: FORONSUBAL186			

GUMMIEXPANDER

WELL NUT®
NEOPRENGUMMI

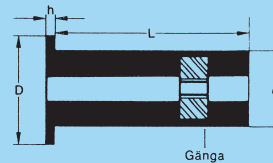

GÄNGA	TYP-BETECKN	GREPP-OMRÅDE	d	D	L	h	ART NR.	FÖRP.	PRIS KR PER 100 ST.
M3	C-632	9,5-15,4	6,1	14,1	24,0	0,9	WELLNUTC632	250	1716
M4	B-832	0,4-3,9	7,9	11,1	11,4	0,7	WELLNUTB832	250	1768
M5	A-1024	0,4-1,3	9,6	14,3	11,1	3,2	WELLNUTA1024	250	1898
M5	10-S	0,4-4,9	9,6	12,7	13,2	0,9	WELLNUT10S	250	1937
M5	Q-1032	0,9-5,9	9,6	14,3	15,9	1,0	WELLNUTQ1032	250	2015
M6	D-1420	0,8-4,7	12,7	18,8	16,3	4,8	WELLNUTD1420	250	2431
M8	E-51618	0,4-4,7	15,7	22,2	15,2	3,2	WELLNUTE51618	250	4433

BEST.EX: GUMMIEXPANDER WELL NUT M3 GREPP 9,5-15,4
DATA.EX: WELLNUTC632

BESTÄLLNINGSAFKTA

Allmänt: Gummiexpandern är avsedd för applikationer med maskinskruv. Den passar material upp till 16,3 mm tjocklek men är idealisk även i bottenhål. En säker och tät infästning som dämpar vibrationer och ljud.

Utförande: Plant huvud. Invulkad mutter i den andra änden.

Material: Neoprengummi. Mutter av mässing.

Mot beställning: Nitrilgummi. UNC/UNF-gänga.

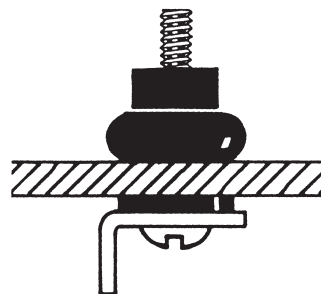

GUMMIEXPANDER

BUFFEX
NEOPRENE/MÄSSING

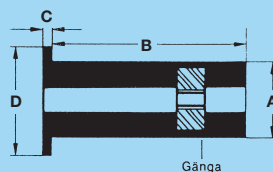

GÄNGA	TYP-BETECKN	GREPP-OMRÅDE	A	B	C	D	ART NR.	FÖRP.	PRIS KR PER 100 ST.
M3	JF-310	0,4-4,0	7,9	12,6	1,40	11,0	BUFFEX310	250	600
M4	JF-410	0,4-4,0	7,9	12,6	1,40	11,0	BUFFEX410	250	600
M5	JF-515	0,4-4,9	9,6	14,1	0,90	12,7	BUFFEX515	250	675
M5	JF-520	4,0-11,6	9,6	21,5	0,90	14,0	BUFFEX520	250	705
M5	JF-525	7,9-16	9,6	26,1	1,30	14,0	BUFFEX525	250	780
M5	JF-540	20,5-30	9,6	39,8	1,30	14,0	BUFFEX540	250	900
M6	JF-615	0,4-2,8	12,7	16,0	1,30	16,0	BUFFEX615	250	975
M6	JF-620	0,8-4,7	12,7	21,1	4,75	17,5	BUFFEX620	250	1100
M6	JF-625	6,4-11,5	12,7	26,7	2,00	16,3	BUFFEX625	250	1100
M8	JF-820	0,4-4,0	15,9	18,3	3,20	22,1	BUFFEX820	250	1350
M8	JF-825	3,95-9,5	15,9	27,93	5,72	22,1	BUFFEX825	250	1425

BEST.EX: GUMMIEXPANDER M3 GREPP 0,4-4,0 NEOPREN/MÄSSING
DATA.EX: BUFFEX310

FJÄDRANDE TRYCKSKRUV

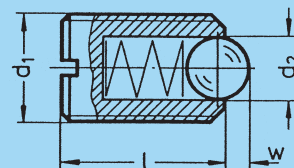

MED KULA

d ₁	d ₂	l	w	ART NR	FÖRPACKNINGAR	PRIS KRONOR PER 100 ST.
M3	1,5	7	0,5	KULGN61503	100	7700
M4	2,5	9	0,8	KULGN61504	100	6100
M5	3	12	0,9	KULGN61505	100	6100
M6	3,5	14	1	KULGN61506	100	6100
M8	5	16	1,5	KULGN61508	100	8500
M10	6	19	2	KULGN61510	100	9300
M12	8	22	2,5	KULGN61512	100	13600
M16	10	24	3,5	KULGN61516	50	18900
M20	12	30	4,5	KULGN61520	25	29300
M24	15	34	5,5	KULGN61524	25	51600

BEST.EX: FJÄDRANDE TRYCKSKRUV GN615 M3 MED KULA

DATA.EX: KULGN61503

UTÖVER OVANSTÅENDE KULSKRUVAR FINNS FÖLJANDE TYPER SOM STANDARD:

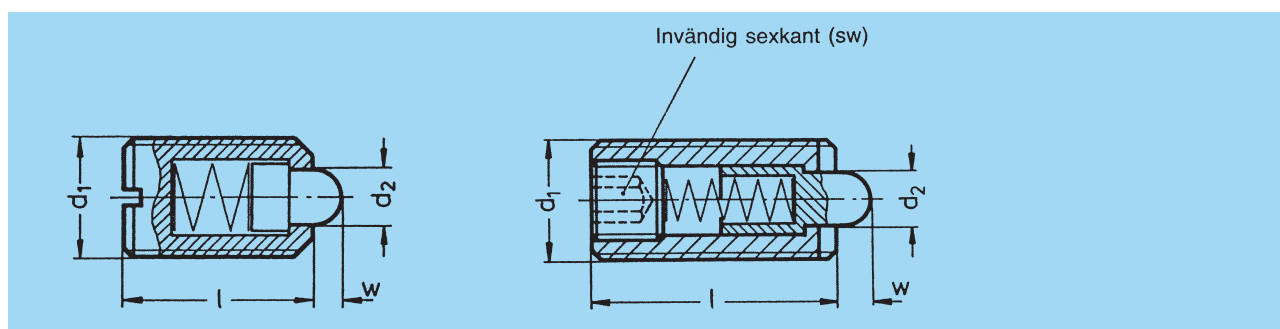

FASTA SKRUVNYCKLAR

DIN 894, DIN 895
ENKLA, DUBBLA
STÅL

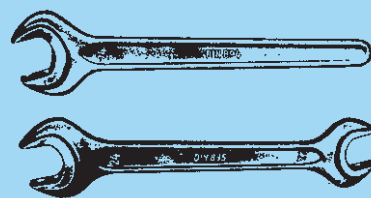

ENKLA	FÖRP.	PRIS KRONOR PER 100 ST.	DUBBLA	FÖRP.	PRIS KRONOR PER 100 ST.
NV 6	10	6750	NV 6 x 7	10	6750
NV 7	10	6300	NV 7 x 8	10	9450
NV 8	10	6300	NV 8 x 9	10	7425
NV 9	10	6750	NV 8 x 10	10	7425
NV 10	10	6750	NV 10 x 11	10	8100
NV 11	10	7200	NV 10 x 12	10	9900
NV 12	10	8100	NV 10 x 13	10	8100
NV 13	10	8100	NV 11 x 13	10	8325
NV 14	10	8325	NV 12 x 14	10	9450
NV 15	10	10350	NV 13 x 14	10	11700
NV 16	10	10350	NV 13 x 15	10	10350
NV 17	10	8550	NV 13 x 17	10	10350
NV 19	10	10800	NV 14 x 15	10	11700
NV 22	10	12600	NV 14 x 17	10	10350
NV 24	10	16650	NV 16 x 17	10	12150
NV 27	10	19350	NV 17 x 19	10	12150
NV 30	10	35100	NV 18 x 19	10	18000
NV 32	10	25650	NV 19 x 22	10	14850
NV 36	1	36000	NV 19 x 24	10	18000
NV 41	1	42975	NV 20 x 22	10	17100
NV 46	1	55800	NV 21 x 23	10	19350
NV 50	1	73800	NV 22 x 24	10	18450
NV 55	1	85500	NV 22 x 27	10	22050
NV 60	1	108000	NV 24 x 27	10	23400
NV 65	1	130500	NV 24 x 30	10	25650
NV 70	1	175500	NV 27 x 32	10	31950
NV 75	1	225000	NV 30 x 32	10	31950
NV 80	1	279000	NV 30 x 36	1	43200
NV 85	1	346500	NV 32 x 36	1	43200
NV 90	1	436500	NV 36 x 41	1	63900
NV 95	1	444000	NV 41 x 46	1	77400
NV 100	1	480000	NV 46 x 50	1	103500
NV 105	1	705000	NV 50 x 55	1	125000
NV 110	1	622500	NV 55 x 60	1	148500
NV 115	1	735000	NV 65 x 70	1	292500
			NV 75 x 80	1	336000

BEST.EX: FAST NYCKEL ENKEL NV 6
DATA.EX: 894006

BITSHÅLLARE BITS

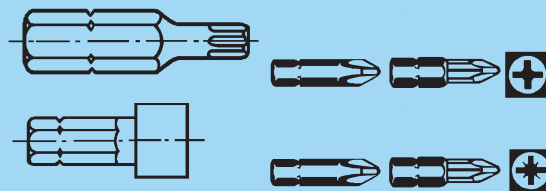

TX-BITS			PHILLIPSBITS		
LÄNGD	PRIS KR PER 100 ST.		SPETS NR	LÄNGD	PRIS KR PER 100 ST.
T 10	25	9225	1	25	2100
T 20	25	9225	2	25	2100
T 25	25	9225	3	25	2100
T 30	25	9225	4	25	7350
T 40	25	9225			
BEST.EX: BITS TX T10 DATA.EX: BITST10			BEST.EX: PHILLIPSBITS NR 1 DATA.EX: BITSH1		
MAGNETHYLSA FÖR BORRSKRUV OCH BITS			POZIDRIVEBITS		
NV	LÄNGD	PRIS KR PER 100 ST.	SPETS NR	LÄNGD	PRIS KR PER 100 ST.
5,5	25	14175	1	25	3150
6,0	25	14175	2	25	3150
7	25	14175	3	25	3150
8	25	14288	4	25	7350
10	25	14400			
1/4	25	14175			
3/8	25	14625			
BEST.EX: MAGNETHYLSA 5,5 DATA.EX: MAGNETHYLSA055			BEST.EX: POZIDRIVESBITS NR 1 DATA.EX: BITSZ1		

VERKTYGSHÅLLARE

SLUTEN
FJÄDERSTÅL FÖRZINKAD

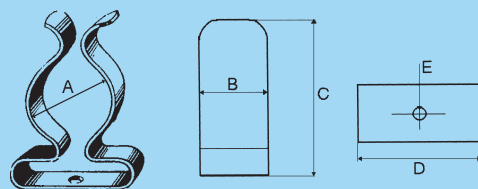

ART.NR	GRIPER OM mm	A= INNER- DIAM.	B= BAND BREDD	C= HÖJD	D= BOTTEN BREDD	E= HÅL- DIAM.	FÖRP.	PRIS KRONOR PER 100 ST.
TCC 061	6-7	6	6,35	15,3	12,9	2,4	1000	300
TCC 101	10-12	10	6,35	20,0	15,5	2,4	1000	314
TCC 131	13-14	13	7,94	26,4	20,1	3,3	1000	422
TCC 161	16-19	16	7,94	32,2	22,6	3,2	1000	536
TCC 191	19-21	19	7,94	36,4	25,3	3,2	1000	588
TCC 251	25-27	25	9,92	40,3	28,8	3,2	500	689
TCC 281	28-31	28	9,52	48,7	34,1	3,6	500	1085
TCC 321	32-34	32	11,11	59,3	42,8	3,6	100	1296
TCC 381	38-40	38	12,70	67,0	49,5	*4,0	100	1733
TCC 511	51-54	51	12,70	80,2	53,0	*4,0	100	2115

BEST.EX: VERKT.HÅLLARE SLUTEN 6 FZB
DATA.EX: TCC061

* TCC 381 2 HÅL MED 8,0 MM CC MÅTT.
* TCC 511 2 HÅL MED 12,7 MM CC MÅTT.

VERKTYGSHÅLLARE

ÖPPEN
FJÄDERSTÅL FÖRZINKAD

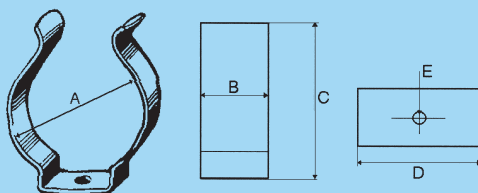

ART.NR	GRIPER OM mm	A= INNER- DIAM.	B= BREDD	C= HÖJD	D= BOTTEN BREDD	E= HÅL- DIAM.	FÖRP.	PRIS KRONOR PER 100 ST.
TCO 061	6-7	6	6,35	10,5	3,8	2,4	500	315
TCO 101	10-12	10	6,35	13,3	4,3	2,4	1000	329
TCO 131	13-14	13	7,94	16,1	5,0	2,4	500	417
TCO 161	16-19	16	7,94	20,5	6,5	2,4	1000	527
TCO 191	19-21	19	9,52	26,6	9,0	3,2	500	575
TCO 251	25-27	25	9,52	30,0	10,2	3,2	500	608
TCO 281	28-31	28	11,11	33,4	12,0	3,6	500	788
TCO 321	32-34	32	11,11	39,0	12,0	3,2	300	833
TCO 381	38-40	38	12,7	48,0	13,0	3,2	100	1205
TCO 511	51-54	51	12,7	61,3	19,5	*3,6	100	1485

BEST.EX: VERKT.HÅLLARE ÖPPEN 6 FZB
DATA.EX: TCO061

*TCO 511 2 HÅL MED 9,5 MM CC MÅTT

BÅDA TYPERNA KAN FÅS POLYETENBELAGDA. FÄRG: SVART ELLER VIT.
PRIS MOT FÖRFRÅGAN.

SORTIMENTLÅDA



PLÅTLÅDA

INNEHÅLL	VÅRT ART. NR.	PRIS KRONOR PER STYCK
FIBERBRICKOR, 18-facklåda 1225 detaljer	S002	5400
FJÄDER- OCH PLANBRICKOR, 18-facklåda 2115 detaljer	S004	3690
SMÖRJNIPPLAR, 18-facklåda 547 detaljer	S011	9990
SMÖRJNIPPLAR, 18-facklåda 274 detaljer	S011B	5963
KOPPARBRICKOR, 18-facklåda 450 detaljer	S015	5079
SPÅRRINGAR SGA, SGH, 18-facklåda 140 detaljer	S018	4395
STJÄRNBRICKOR, 18-facklåda 1225 detaljer	S020	4244
PLÅTSKRUV CSS,KFSS,18-facklåda 1425 detaljer	S021	3973
PLÅTSKRUV CSS, 18-facklåda 700 detaljer	S025	3599
POLYAMIDSKRUV inkl. MUTTER OCH BRICKA, 18-facklåda 660 detaljer	S029	6590
SPÅRSKRUV MCS inkl. MUTTER, 18-facklåda 1800 detaljer	S030	3778
SPÅRSKRUV MRX, 18-facklåda 1800 detaljer	S032	4411
SPÅRRINGAR SGA, SGH, 12-facklåda 160 detaljer	S033	4924
6-KANTSKRUV UNC FZB inkl. MUTTER, 12-facklåda 420 detaljer	S037	5641
6-KANTSKRUV UNF FZB inkl. MUTTER, 12-facklåda 415 detaljer	S038	6979
6-KANTSKRUV MM FZB inkl. MUTTER, 18-facklåda 530 detaljer	S043	4481
6-KANTSKRUV MM FZB inkl. MUTTER,12-facklåda 370 detaljer	S044	4258
KAROSSERIBRICKOR, 12-facklåda 690 detaljer	S049	4482
PLÅTSKRUV 6KSS, 12-facklåda 600 detaljer	S054	4774
PLÅTSKRUVBRICKOR, 12-facklåda 1100 detaljer	S055	8348
SPÄNNSTIFT, 18-facklåda 375 detaljer	S057	3944
WOODRUFFKILAR, 18-facklåda 135 detaljer	S058	5190
SPÅRRYTARE, 12-facklåda 270 detaljer	S059	3986
KUPADE BRICKOR, 12-facklåda 1370 detaljer	S061	4538

BEST.EX: SORTL. PLÅT FIBERBR. 18-FACK NR. S002
DATA.EX: S002

**FÖR UTFÖRLIGARE INFORMATION OM SORTIMENTLÅDORNAS INNEHÅLL,
KONTAKTA VÅR FÖRSÄLJNINGSAVDELNING.**

SORTIMENTLÅDA



PLÅTLÅDA

INNEHÅLL	VÅRT ART. NR.	PRIS KRONOR PER STYCK
ALUMINIUMBRICKOR, 12-facklåda 600 detaljer	S063	3997
SHIMS, 18-facklåda 540 detaljer	S065	5385
PLÅTSKRUV RXS, KFXS, 18-facklåda 1300 detaljer	S066	3985
PLÅTSKRUV RXS, 18-facklåda 900 detaljer	S067	3864
PLÅTSKRUV KFXS inkl. förs. bricka, 18-facklåda 1100 detaljer	S068	4592
SNABBMUTTER SFP,SNP, 12-facklåda 355 detaljer	S071	4438
O-RINGAR (AM.STANDARD), 18-facklåda 450 detaljer	S074	3722
O-RINGAR (SVENSK.STANDARD), 18-facklåda 450 detaljer	S075	3646
INV.6-KANT MM, 18-facklåda 350 detaljer	S078	5087
INV.6-KANT UNC, 12-facklåda 200 detaljer	S079	6449
SPÅRSKRUV FS inkl MUTTER, 18-facklåda 1740 detaljer	S083	4279
POPINIT MONEL, 12-facklåda 1002 detaljer	S084	7767
NYLONBRICKOR, 12-facklåda 267 detaljer	S086	5371
PINNBULT, 12-facklåda 120 detaljer	S089	5610
PLATTKILAR, 12-facklåda 100 detaljer	S090	4420
CYL.PINNAR, 12-facklåda 255 detaljer	S091	4885
KONISKA PINNAR, 18-facklåda 245 detaljer	S092	5712
BLINDNIT(ALUMINIUM), 12-facklåda 1002 detaljer	S093	5365
BLINDNIT(ALUMINIUM), 20-facklåda 500 detaljer	S093B	3173
O-RINGAR(SVENSK STANDARD), 18-facklåda 900 detaljer	S094	4050
STOPPSKRUV MM, 18-facklåda 135 detaljer	S095	3860
STOPPSKRUV UNC, 12-facklåda 100 detaljer	S096	5245
BRB BRICKOR, 12-facklåda 1060 detaljer	S097	3986
PLASTBRICKOR, 18-facklåda 445 detaljer	S099	3944
TREDORINGAR, 20-facklåda 150 detaljer	S100	5775
SAXPINNAR, 12-facklåda 780 detaljer	S101	4122
STARLOCK LÅSBRICKOR, 12-facklåda 950 detaljer	S103	5130
VIKBRICKA, DIN 93, 12-facklåda 315 detaljer	S105	5635
STAGBULT HCB, 12-facklåda 72 detaljer	S106	7403
ROSTFRIA SAXPINNAR, 12-facklåda 800 detaljer	S107	10705
SAXPINNAR, 18-facklåda 3350 detaljer	S109	4940
PLÅTSKRUV SVART RXS & KFXS, 18-facklåda 825 detaljer	S111	5295
SJÄLVBORRANDE PLÅTSKRUV RXB & HB, 18-facklåda 650 detaljer	S112	5420
ROSTFRI PLÅTSKRUV RXS & KFXS, 18-facklåda 600 detaljer	S120	7306
ROSTFRI M-BULT + MUTTER & BRICKOR, 18-facklåda 190 detaljer	S122	5657
ROSTFRI SPÅRSKRUV + MUTTER & BRICKOR, 18-facklåda 380 detaljer	S126	5670
BEST.EX: SORTL. PLÅT ALUMINIUMBR. 12-FACK NR. S063 DATA.EX: S063		

**FÖR UTFÖRLIGARE INFORMATION OM SORTIMENTLÅDORNAS INNEHÅLL,
KONTAKTA VÅR FÖRSÄLJNINGSAVDELNING.**

SORTIMENTLÅDA



PLASTLÅDA

INNEHÅLL	VÅRT ART. NR.	PRIS KRONOR PER STYCK
*6-KANTSKRUV U6S, 15-facklåda 195 detaljer	SP40621	2040
*SPÅRSKRUV MCS M. MUTTER, 15-facklåda 540 detaljer	SP41811	1200
*PLÅTSKRUV RXS, KFXS, 6KSS, 15-facklåda 365 detaljer	SP42215	2070
*PLÅTSKRUV CSS, 15-facklåda 590 detaljer	SP42223	1530
*TAGGLÅSBRICKOR AZ, IZ, 18-facklåda 940 detaljer	SP43031	1980

BEST.EX: SORTIMENT 6-KANTSKRUV U6S
DATA.EX: SP40611
* Kommer att utgå

**FÖR UTFÖRLIGARE INFORMATION OM SORTIMENTLÅDORNAS INNEHÅLL,
KONTAKTA VÅR FÖRSÄLJNINGSAVDELNING.**