











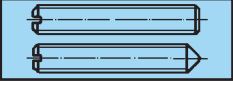
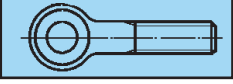

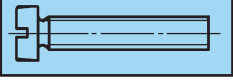







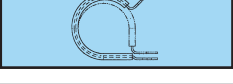
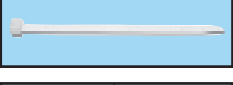

Other articles/Übrige Artikeln

Page/Seite

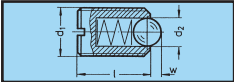
	DIN 417 Steel/Stahl Plain/unbeh	19:1
	DIN 438 Steel/Stahl Plain/unbeh	19:2
	DIN 551 Steel/Stahl Plain/unbeh	19:3
	DIN 553 Steel/Stahl Plain/unbeh	19:3
	DIN 444 B Steel/Stahl Plain/unbeh	19:4
	DIN 963 Polyamide/polyamid	19:5
	DIN 84 Polyamide/polyamid	19:6
	DIN 933 Polyamide/polyamid	19:7
	DIN 125 Polyamide/polyamid	19:8
	DIN 555 Polyamide/polyamid	19:8
	DIN 1587 Polyamide/polyamid	19:8
	DIN 787 T-Bolts/T-Bolzen	19:9
	Hose clamps/Rohr- und Schlauchschellen HDG/feuerverz Zincpl/verz	19:10
	Hose clamps/Rohr- und Schlauchschellen HDG Zincpl/verz	19:11
	Rubberclamps/Gummiklammer Steel/Stahl Zincpl/verz Stainless steel/rostfrei	19:12
	Cable ties/Kabelverbinder	19:13
	Lubr.nipple/Schmiernippel	19:14
	Round fiber washer/Runde Fiberscheibe	19:15
	Suspension lug nuts/Befestigungsösen	19:16

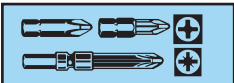
Other articles/Übrige Artikeln

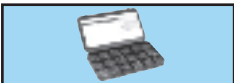
		Page/Seite
	Rubber expander/Gummiexpander WELL NUT [®] + BUFFEX	19:17
	Slotted spring plungers with ball/ Federnde Druckstücke mit Kugel und Schlitz Steel/Stahl	19:18
	Single – head jaw wrench/Einmaulschlüssel single/einfach Double/doppel	19:19
	Bits Sockets for drill screws and bits/Hülse für Bohrschrauben und Bits	19:20
	Tool clips/stahlhalter closed/Geschlossen and/und open/offen	19:21
	Box assortment/Sortimentskiste	19:22, 19:23, 19:24

DIN 417

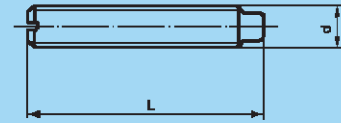

Steel/Stahl Plain/unbeh

d	M3	M4	M5	M6	M8	M10	M12	M16
L	Price/Preis €/1000 pcs/St							
5	189	189						
6	189	189	216	242	320			
8	189	192	219	242	309			
10	192	197	225	246	327	531		
12	207	197	228	260	350	558	990	
16	237	219	242	275	395	608	1070	
18	252	243	284	309	428	687	1125	
20	261	260	297	320	467	765	1238	2633
22	270	266	306	347	494	810	1328	2813
25	270	297	318	365	518	855	1328	2813
30	315	350	374	426	620	935	1575	2970
35		392	450	473	675	990	1688	3150
40		450	521	575	732	1115	1913	3285
45				653	845	1193	2160	3623
50				720	945	1305	2430	3983
55					1148	1350	2723	4320
60					1328	1575	2993	4658

Order ex./Best. ex: DIN 417 Steel/Stahl M3 x 5 Plain/unbeh
Article ex./Artikelnr ex.: 41703005

Box quantity/Verpackung

Pcs/St	M3	M4	M5	M6	M8	M10	M12	M16
100	5-30	5-40	6-40	6-50	6-60			
50						10-60	12-60	20-60

DIN 438

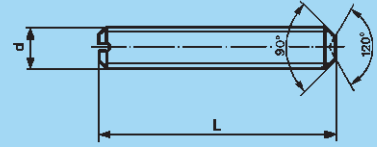

Steel/Stahl Plain/unbeh

d	M3	M4	M5	M6	M8	M10
L	Price/Preis €/1000 pcs/St					
3	189					
4	189	198				
5	189	189	215			
6	189	189	216	242		
8	189	192	219	242	309	
10	192	197	225	246	327	467
12	207	197	228	260	350	494
16	237	219	242	275	395	
18		243		320		
20		260	297	320	467	
25		297	318	365	518	
30				426	620	867

Order ex./Best. ex. DIN 438 Steel/Stahl M3 x 3 Plain/unbeh
 Article ex./Artikelnr ex.: 43803003

Box quantity/Verpackung

Pcs/St	M3	M4	M5	M6	M8	M10
100	3-16	4-25	5-25	6-30	8-30	10-30

DIN 551 DIN 553 (ISO 4766, ISO 7434)

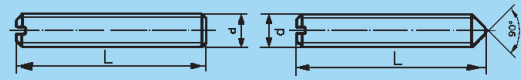

Steel/Stahl Plain/unbeh

d	M1,4	M1,6	M2	M2,5	M3	M4	M5	M6	M8	M10
L	Price/Preis €/1000 pcs/St									
2	279	260								
3	279	260	176	201	129	158				
4	279	261	180	201	129	140	183	203		
5	284	270	201	206	129	131	153	185	284	
6	293	284	210	219	129	135	156	176	284	419
8	309	300	219	233	129	135	158	176	273	419
10		327	233	246	131	138	165	183		419
12				260	144	144	167	192	269	431
16				275	185	167	180	206	306	476
18					197	197	233	251	374	539
20					206	210	242	246	368	597
22					246	246	248	284	431	630
25					246	246	257	284	413	675
30					257	287	306	374	522	743
35						345	392	413	563	788
40						395	450	503	620	890
45								563	698	980
50								620	800	1070
60								1125	1125	1260
70									1395	1620
80									1688	1980

Order ex./Best. ex: DIN 551 Steel/Stahl M1,4 x 2 Plain/unbeh
Article ex./Artikelnr ex.: 551014002

Box quantity/Verpackung

Pcs/St	M1,4	M1,6	M2	M2,5	M3	M4	M5	M6	M8	M10
200			3-10	3-16	3-30	3-30	4-30	4-22		
100	2-8	2-10				35-40	35-40	25-60	5-80	6-80

DIN 444 B

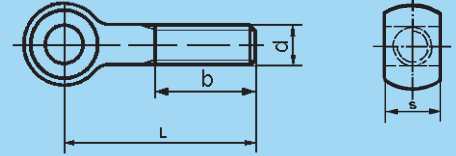

Steel/Stahl 4.6 Plain/unbeh

d	M5	M6	M8	M10	M12	M16	M20	M24	M30
b*	16	18	22/28	26/32	30/36	38/44	46/52	54/60	66/72
s	6	7	9	12	14	17	22	25	30
L	Price/Preis €/1000 pcs/St								
25	6300	6300	7088	7988	13163				
30	6300	6300	7088	7988	8775				
35	5738	5738	7200	8100	9000				
40	5738	5738	7425	8438	9000	15075			
45		6300	7538	8550	9450	15075			
50		6300	7538	8550	10238	15075			
55		6750	7650	8888	10688	15075			
60		6750	7650	13332	10688	15075			
65		7988	7988	9113	10800	15525			
70		7988	7988	9113	10800	15525			
75		9225	8213	9338	10800	16200			
80		9225	8213	9338	10800	16200	21600	30825	
90			8438	9788	10913	16875	22275	31950	
100			8888	9788	12375	16875	34763	33525	
110			10125	10238	12600	17550	24075	35325	
120			10800	16032	13500	18225	24750	36900	72000
130			11475	11138	14625	18450	25425	38700	73125
140			11925	11925	15525	18900	26325	40500	75250
150					16875	19575	27900	42525	75375
160					19350	20250	28575	44325	77625
170					19800	20700	30150	46575	81000
180					20250	21375	30825	49050	84375
190					21375	22275	31950	52650	87750
200					21825	23175	32175	54000	91125
*thread length for L=25-125 and for L=130-200 / *Gewindelängen für L=25-120 und für L=130-200 /									
Order ex./Best. ex: DIN 444b Steel/Stahl M5 x 25 DATA.EX: 444B05025									

Box quantity/Verpackung

Pcs/St	M5	M6	M8	M10	M12	M16	M20	M24	M30
50	25-40	25-40	25-35	25-35					
25		45-80	40-140	40-110	25-45				
10				120-140	50-140	40-120			
Loose/ Lose					150-200	130-200	80-200	80-200	120-200

DIN 963

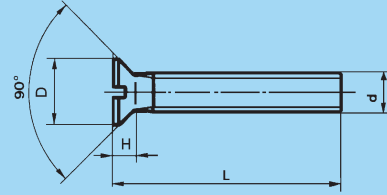

Polyamide/polyamid

d	M3	M4	M5	M6	M8	M10
D	5,6	7,5	9,2	11	14,5	18
H	1,65	2,2	2,5	3	4	5
L	Price/Preis €/1000 pcs/St					
6	338	360				
8	323	387	426			
10	333	399	426	486		
12	347	413	441			
16	354	419	512	554	1040	
20	377	441	545	617	1112	
25	404	467	585	687	1160	2136
30	437	486	629	759	1317	2331
35		521	671	813	1449	
40			710	945	1521	
45				977		
50				993	1701	2907
60				1049	1899	
70					2048	
Order ex./Best. ex.: DIN 963 Polyamide/polyamid M3 x 6 Article ex./Artikelnr ex.: 963P03006						

Box quantity/Verpackung

Pcs/St	M3	M4	M5	M6	M8	M10
100	6-30	6-35	8-40	10-60	16-70	25-50

DIN 84

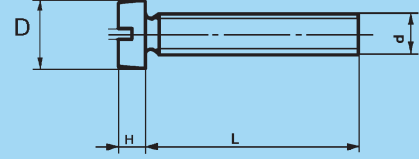

Polyamide/polyamid

d	M3	M4	M5	M6	M8	M10
D	5,5	7	8,5	10	13	16
H	2	2,6	3,3	3,9	5	6
L	Price/Preis €/1000 pcs/St					
3	354					
4	354					
5	450					
6	320	347	399	460		
8	333	359	404	471		
10	347	367	401	459	945	
12	347	377	408	446		
16	354	392	426	491	1034	
18	392	399				
20	377	387	549	531	1128	2105
25	404	426	561	611	1197	2268
30	417	450	606	743	1292	2483
35	480		644	782	1349	2663
40	494		680	813	1412	2876
45				836		2993
50			759	860	1512	3087
60				908	1931	3308
70				962	2136	3402
80					2285	
Order ex./Best. ex: DIN 84 Polyamide/polyamid M3 x 3 Article ex./Artikelnr ex.: 84P03003						

Box quantity/Verpackung

Pcs/St	M3	M4	M5	M6	M8	M10
100	3-30	6-40	6-50	5-70	10-80	20-70

DIN 933

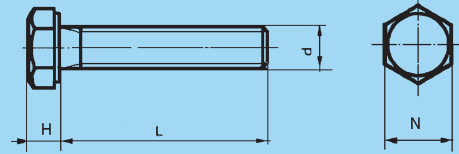

Polyamide/polyamid

d	M4	M5	M6	M8	M10	M12	M16
D	7	8	10	13	17	19	24
H	2,8	3,5	4	5,5	7	8	10
L	Price/Preis €/1000 pcs/St						
6	347	399	590	790			
8	359	408	538				
10	372	419	467	945			
12	377	426	498				
16	392	471	498	1034			
20	408	549	561	1128	2105	2457	
25	426	561	611	1197	2268	2979	
30	450	606	743	1292	2483	3119	
35		644	782	1349	2672	3261	
40	494	680	813	1412	2750	3261	
45			836		2993	3576	
50		759	860	1443	3087	3749	5529
55					3198		6096
60			908	1931	3308	4064	6426
70			962	2136	3402	4379	8316
75			993				
80				2294	3528	4679	
90							10065

Order ex./Best. ex: DIN 933 Polyamide/polyamid M4 x 6
Article ex./Artikelnr ex.: 933P04006

Box quantity/Verpackung

Pcs/St	M4	M5	M6	M8	M10	M12	M16
100	6-40	6-50	6-75	6-80	20-80	20-80	50-90

DIN 125

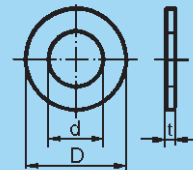

Polyamide/polyamid

For screw/ Für Schrauben	d	D	t	Box quantity/Verpackung	Price/Preis €/1000 pcs/St
M2	2,2	5	0,3	1000	45
M2,5	2,7	6	0,5	1000	45
M3	3,2	7	0,5	1000	47
M3,5	3,7	8	0,5	1000	62
M4	4,3	9	0,8	1000	62
M5	5,3	10	1	1000	90
M6	6,4	12	1,6	1000	137
M8-5/16	8,4	16	1,6	1000	189
M10	10,5	20	2	500	306
M12	13	24	2,5	100	530
M16-5/8	17	30	3	100	638
M20	21	37	3	100	1140

Order ex./Best. ex: DIN 125 Polyamide/polyamid 2,7
Article ex./Artikelnr ex.: 125P027

DIN 555

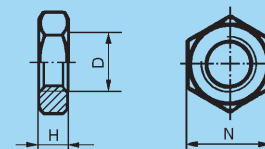

Polyamide/polyamid

D	N	H	Box quantity/Verpackung	Price/Preis €/1000 pcs/St
M3	5,5	2,4	100	314
M4	7	3,2	100	342
M5	8	4	100	392
M6	10	5	100	419
M8	13	6,5	100	630
M10	17	8	100	1134
M12	19	10	100	1364
M16	24	13	100	2483

Order ex./Best. ex: DIN 555 Polyamide/polyamid M3
Article ex./Artikelnr ex.: 555P03

DIN 1587

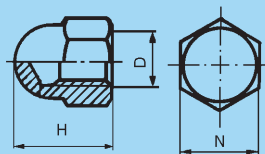

Polyamide/polyamid

D	N	H	Box quantity/Verpackung	Price/Preis €/1000 pcs/St
M3	5,5	6,3	100	539
M4	7	8	100	603
M5	8	10	100	729
M6	10	12	100	755
M8	13	15	100	1119
M10	17	18	100	1884
M12	19	22	100	2231
M16	24	28	100	3969

Order ex./Best. ex: DIN 1587 Polyamide/polyamid
Article ex./Artikelnr ex.: 1587P03

DIN 787 T-bolts/T-Bolzen



Steel/Stahl 8.8

Band width / Schlitzbreite a	Dimension/Maß d	Length/Länge	Price/Preis €/1000 pcs/St
6	M6	25	23175
6	M6	40	23175
6	M6	63	24975
8	M8	32	24975
8	M8	50	25425
8	M8	80	26550
10	M10	40	23625
10	M10	63	25425
10	M10	100	26550
12	M12	50	25425
12	M12	63	26100
12	M12	80	27000
12	M12	125	29700
12	M12	200	35550
14	M12	50	26100
14	M12	80	27450
14	M12	125	31275
14	M12	200	36000
16	M14	63	32625
16	M14	100	36450
16	M14	160	44325
16	M14	250	51525
16	M16	63	35550
16	M16	80	36450
16	M16	100	38700
16	M16	160	43875
16	M16	200	48600
16	M16	250	51150
18	M16	63	37800
18	M16	80	38700
18	M16	100	39600
18	M16	160	45450
18	M16	200	48600
18	M16	250	53325
20	M20	80	55800
20	M20	125	58050
20	M20	160	60075
20	M20	200	67950
20	M20	315	79425
22	M20	80	57150
22	M20	100	59175
22	M20	125	60525
22	M20	160	64350
22	M20	200	72225

Box quantity according to request / wunschgemässe Verpackung

Order ex./Best. ex: DIN 787 Steel/Stahl M6 x 25

Article ex./Artikelnr ex.: 7870606025

Hose clamps/ Rohr- und Schlauchschellen



Steel/Stahl Zincl/verz

Diameter/Diameter	Thread/Gewinde	Box quantity/ Verpackung	Article/Artikelnr	Price/Preis €/1000 pcs/St
25 mm	M8	10	58232025	2543
28 mm	M8	10	58232028	2635
32 mm	M8	10	58232032	1647
35 mm	M8	10	58232035	1719
38 mm	M8	10	58232038	1755
42 mm	M8	10	58232042	1751
45 mm	M8	10	58232045	1814
48 mm	M8	10	58232048	2016
51 mm	M8	10	58232051	2093
54 mm	M8	10	58232054	2201
57 mm	M8	10	58232057	2205
60 mm	M8	10	58232060	2318
64 mm	M8	10	58232064	2430
67 mm	M8	10	58232067	2633
70 mm	M8	10	58232070	2745
73 mm	M8	10	58232073	2835
76 mm	M8	10	58232076	2970
83 mm	M8	10	58232083	4995
89 mm	M8	10	58232089	5400
95 mm	M8	10	58232095	5715
102 mm	M8	10	58232102	5895

Order ex./Best. ex: Hose clamps/Rohr- und Schlauchschellen 582 32025 25 mm Zincl/verz
Article ex./Artikelnr ex.: 58232025

Hose clamps/Schlauchschellen

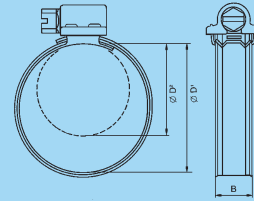

Zincpl/verz

Clamp range/ Ø Spannbereich / Ø	Breadth mm/ Breiten mm	Box quantity/ Verpackung	Price/Preis €/1000 pcs/St
11-17	9	50	1850
13-20	9	50	1904
15-24	12	50	1904
19-28	12	50	1904
22-32	12	50	2120
26-38	12	50	2120
32-44	12	50	2120
38-50	12	50	2295
44-56	12	50	2295
50-65	12	50	2538
58-75	12	50	2741
68-85	12	50	3051
77-95	12	50	3227
87-112	12	50	3456
104-138	12	50	3752
130-165	12	50	4307
150-180	12	50	5022
175-205	12	50	5522
200-231	12	50	6102
226-256	12	25	6750
251-282	12	25	7425
277-307	12	25	8033

Order ex./Best. ex: Hose clamps/Schlauchschellen 11-17
Article ex./Artikelnr ex.: SLANG1117

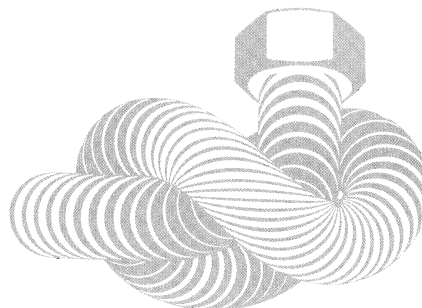

Rubberclamps/Gummiklammer

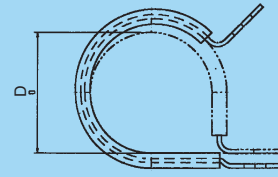

Steel/Stahl Zincl/verz
Stainless Steel/rostfrei 2333 (A2)

D	Box quantity/ Verpackung	Steel/Stahl		Stainless steel/Rostfrei	
		Our article/ Unser Artikel	Price/Preis €/1000 pcs/St	Our article/ Unser Artikel	Price/Preis €/1000 pcs/St
3 MM	100	GUM003	780	GUMA2003	2655
5 MM	100	GUM005	810	GUMA2005	2925
6 MM	100	GUM006	860	GUMA2006	3090
8 MM	100	GUM008	870	GUMA2008	3120
10 MM	100	GUM010	900	GUMA2010	3150
11 MM	100	GUM011	980	GUMA2011	3240
13 MM	100	GUM013	1110	GUMA2013	3600
14 MM	100	GUM014	1170	GUMA2014	3720
16 MM	100	GUM016	1220	GUMA2016	5738
18 MM	50	GUM018	1350	GUMA2018	3945
19 MM	50	GUM019	1460	GUMA2019	4215
21 MM	50	GUM021	1520		
22 MM	50	GUM022	1580	GUMA2022	4394
24 MM	50	GUM024	1650		
25 MM	50	GUM025	1740	GUMA2025	6930
27 MM	50	GUM027	1920		
29 MM	50	GUM029	2000	GUMA2029	5070
30 MM	50	GUM030	2030		
32 MM	50	GUM032	3180	GUMA2032	6075
33 MM	50	GUM033	3260		
35 MM	50	GUM035	3320	GUMA2035	6300
36 MM	50	GUM036	3390		
38 MM	50	GUM038	3450	GUMA2038	6525
41 MM	50	GUM041	3980		
45 MM	25	GUM045	4110	GUMA2045	7800
47 MM	25	GUM047	4310		
51 MM	25	GUM051	4530		
54 MM	25	GUM054	4790		
57 MM	25	GUM057	4940		
60 MM	25	GUM060	5090		
63 MM	25	GUM063	5240		
65 MM	25	GUM065	5360		
72 MM	10	GUM072	5660		
74 MM	10	GUM074	5850		
81 MM	10	GUM081	5910		
100 MM	10	GUM100	7280		
110 MM	10	GUM110	7710		

<p>Order ex./Best. ex: Rubberclamps/Gummiklammer Steel/Stahl 3 mm HDG/feuerverz</p> <p>Article ex./Artikelnr ex.: GUM003</p>	<p>Order ex./Best. ex: Rubberclamps/ Gummiklammer stainless A2 3 mm</p> <p>Article ex./Artikelnr ex.: GUMA2003</p>
--	--

Cables Ties/Kabelverbinder



Polyamide/Polyamid 6.6

Natural	Black/ Schwarz	Size/ Größe	Bag/ VPE	Box quantity/ Verpackung	Price/Preis €/1000 pcs/St
CABLE5201	CABLE5301	75x2,2	100	60000	38
CABLE5203	CABLE5303	98x2,5	100	40000	26
CABLE5205	CABLE5305	135x2,5	100	35000	47
CABLE5206	CABLE5306	160x2,6	100	35000	57
CABLE5207	CABLE5307	200x2,6	100	25000	85
CABLE5208	CABLE5308	370x3,6	100	10000	244
CABLE5209	CABLE5309	140x3,6	100	25000	69
CABLE5210	CABLE5310	290x3,6	100	15000	133
CABLE5211	CABLE5311	160x4,5	100	15000	117
CABLE5212	CABLE5312	450x4,5	100	25000	87
CABLE5213	CABLE5313	178x4,8	100	15000	119
CABLE5214	CABLE5314	200x3,6	100	20000	106
CABLE5215	CABLE5315	200x4,8	100	13000	118
CABLE5216	CABLE5316	250x4,8	100	10000	150
CABLE5217	CABLE5317	290x4,8	100	10000	190
CABLE5218	CABLE5318	390x4,8	100	7000	300
CABLE5219	CABLE5319	360x4,8	100	7500	243
CABLE5220	CABLE5320	430x4,8	100	6000	338
CABLE5221	CABLE5321	120x7,8	100	9000	246
CABLE5223	CABLE5323	180x7,8	100	6000	272
CABLE5225	CABLE5325	240x7,8	100	5000	349
CABLE5226	CABLE5326	300x7,8	100	4000	394
CABLE5227	CABLE5327	365x7,8	100	3500	469
CABLE5229	CABLE5329	450x7,8	100	3000	675
CABLE5231	CABLE5331	540x7,8	100	2000	993
CABLE5233	CABLE5333	750x7,8	100	2000	1254
CABLE5234	CABLE5334	780x9,0	100	1300	1435
CABLE5235	CABLE5335	225x12,6	50	2000	825
CABLE5237	CABLE5337	500x12,6	50	1000	1407
CABLE5239	CABLE5339	720x12,6	50	1000	1688
CABLE5241	CABLE5341	850x12,6	50	1500	1494
CABLE5243	CABLE5343	1000x12,6	50	1000	2813

Order ex./Best. ex: Buntband 75 x 2,2 Natur

Article ex./Artikelnr ex.: CABLE5201

Polyamide/polyamid 6.6 – Characteristics of raw material/Eigenschaften des Rohmaterials

Humidity absorption/Feuchtigkeitsabsorption	2,5% (50% relative humidity/50% relative Feuchtigkeit)
Working temperature/Arbeitstemperatur	-40°C to/bis +85°C
Tightening temperature/Haltbarkeitstemperatur	-10°C to/bis +60°C
Max Admissible point/Max zulässiger Punkt	+110°C for short time/für kurze Zeit
Fusion temperature/Schmelztemperatur	+256°C
Limit Oxygen Index/Mindestsauerstoffgehalt	27%
Flammability Rating/Enflammbarkeits Bemessungsdaten	UL94 class V2/UL94 Klasse V2
Dielectric strength/Dielektrische Durchschlagfestigkeit	50.000 volts/mm/50.000 Volt mm
Weather resistance/Witterungsbeständigkeit	High resistance to bases, oils, greases, oil derivates, chloride solvents/ Hohe Beständigkeit gegen Säuren, Fette, Öle Ölverbindungen und Chloridlösungen. Limited resistance to acids/Begrenzte Beständigkeit gegen starke Säuren und Acide. Not resistant to phenols/Keine Beständigkeit gegen Pnenole und Karbol. Halogen-free resins/Halogenfreie Epoxide.





Lubr.nipple/ Schmiernippel

Steel/Stahl
Zincpl/verz

M-thread/M-gewinde: Conical acc. to/Konische nach DIN 158
R-thread/R-gewinde: Conical Withworth thread acc. to/
Konische Rohrgewinde nach ISO 7/1
SAE-thread/SAE-gewinde: Conical UNF-thread/Konische UNF-gewinde
W-thread/W-gewinde: Cylindrical Withworth/Cylindrische Withworth.

Designation/ Bezeichnung	Article/ Artikelnr	Box q/ Verp.	Thread/ Gewinde	Price/Preis €/1000 pcs/St	Designation/ Bezeichnung	Article/ Artikelnr	Box q/ Verp.	Thread/ Gewinde	Price/Preis €/1000 pcs/St
Straight/ Gerade					Angle 90 degree/ winkel 90 gr				
509	509	100	R 1/8	642	535	535	100	R 1/8	1223
512	512	100	R 1/4	986	538	538	100	R 1/4	1499
513	513	100	SAE 1/4	540	525	525	100	SAE 1/4	1223
585	585	100	M6 x 0,75	791	589	589	100	M6 x 0,75	1512
504	504	100	M6 x 1	540	576	576	100	M6 x 1	1242
586	586	100	M8 x 0,75	791	590	590	100	M8 x 0,75	1512
505	505	100	M8 x 1	791	577	577	100	M8 x 1	1512
507	507	100	M8 x 1,25	791	514	51490	100	M8 x 1,25	1512
580	580	100	M10 x 1	642	583	583	100	M10 x 1	1223
516	516	100	W1/4	791	516	51690	100	W 1/4	1512
510	510	100	W5/16	1512	517	517	100	W 5/16	2214
511	511	100	W 3/8	1404	518	518	100	W 3/8	2214
506	506	100	M7 x 1	1404					
515	515	100	R 3/8	2795					
Angle 45 degree/ winkel 45 gr					Straight/ Gerade				
519	519	100	R 1/8	1223	1698 - 30 MM	1698	100	SAE 1/4	3059
512 B	51245	100	R 1/4	1499	1697 - 30 MM	1697	100	M6 x 1	2039
547	547	100	SAE 1/4	1223					
587	587	100	M6 x 0,75	1512	Push in/ Einschuz				
560	560	100	M6 x 1	1242	500	500	100	Ø6	642
588	588	100	M8 x 0,75	1512	501	501	100	Ø8	642
505 B	50545	100	M8 x 1	1499					
514 B	51445	100	M8 x 1,25	1499					
584	584	100	M10 x 1	1223					
549	549	100	W 1/4	1512					

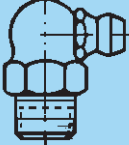
Order ex./Best. ex: Lubr.nipple/Schmiernippel straight/gerade 509 R 1/8
Article ex./Artikelnr ex.: 509

Straight/gerade	Angle 45 degree/ Winkel 45 gr	Angle 90 degree/ Winkel 90 gr	Push in/ Einschuz
			

Round fiber washer/ Runde Fiberscheibe

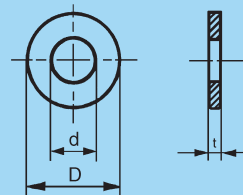

For screw/ Für Schrauben	d	D	t	Article/ Artikelnr	Price/Preis €/1000 pcs/St
M2	2,7	6,0	1,0	FIB0270610	54
M2	2,8	5,0	0,5	FIB0280505	116
M3	3,0	6,5	1,0	FIB03006510	65
M3	3,1	5,5	1,0	FIB03105510	54
M3	3,2	8,0	1,0	FIB0320810	62
M3	3,5	7,0	0,5	FIB0350705	128
M3	3,5	8,0	1,0	FIB0350810	117
M3	3,7	6,0	1,0	FIB0370610	59
M4	4,0	8,0	1,0	FIB0400810	52
M4	4,1	8,0	1,0	FIB0410810	52
M4	4,5	10,0	1,0	FIB04510010	65
M5	5,0	9,0	1,0	FIB0500910	120
M5	5,0	10,0	1,0	FIB0501010	189
M5	5,3	9,0	1,0	FIB0530910	67
M6	6,0	10,0	1,0	FIB0601010	71
M6	6,0	11,0	1,0	FIB0601110	189
M6	6,0	15,0	1,0	FIB0601510	189
M6	6,5	11,0	1,0	FIB0651110	189
M8	8,0	12,0	1,0	FIB0801210	192
M8	8,0	13,0	1,0	FIB0801310	189
M8	8,0	14,0	1,0	FIB0801410	152
M8	8,1	14,0	1,0	FIB0811410	152
M8	9,0	15,0	1,0	FIB0901510	152
M10	10,0	14,0	1,0	FIB1001410	256
M10	10,0	15,0	1,0	FIB1001510	189
M10	10,0	18,0	1,0	FIB1001810	352
M10	11,0	16,0	1,0	FIB1101610	352
M10	11,5	18,0	1,0	FIB1151810	352
M12	12,0	16,0	1,0	FIB1201610	320
M12	12,0	16,0	1,5	FIB1201615	320
M12	12,7	19,0	1,0	FIB1271910	480
M12	13,0	18,0	1,5	FIB1301815	480
M12	13,0	20,0	1,0	FIB1302010	496
M14	14,0	20,0	1,5	FIB1402015	400
M14	14,5	21,0	1,0	FIB1452110	496
M16	16,0	20,0	1,0	FIB1602010	496
M16	16,0	20,0	1,5	FIB1602015	496
M16	16,0	25,0	1,0	FIB1602510	669
M16	17,0	25,0	1,0	FIB1702510	669
M18	18,0	22,0	1,5	FIB1802215	448
M20	20,0	24,0	1,5	FIB2002415	496
M20	20,0	30,0	1,0	FIB2003010	1690
M20	21,0	31,0	1,0	FIB2103110	1074
M22	23,0	33,0	1,0	FIB2303310	1189
M27	29,0	38,0	1,0	FIB2903810	1507
M33	33,0	42,0	1,0	FIB3304210	1507

Order ex./Best. ex: Found fiber washer/Runde Fiberscheibe 2,7 x 6 x 1,0
Article ex./Artikelnr ex.: RWF0270610

Box quantity/Verpackung

Pcs/St	d
1000	2-10
500	11-33

Suspension lug nuts aducerad/ Befestigungsösen aducerad

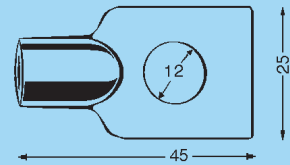

Zincpl/verz

Designation/ Bezeichnung	Inside thread/ Innengewinde	Box quantity/ Verpackung	Price/Preis €/1000 pcs/St
BO 25/6	M6	50	3218
BO 25/8	M8	50	3263
BO 25/10	M10	50	3428

Order ex./Best. ex: Suspension lug nuts aducerad/Befestigungsösen aducerad BO 25/6 M6
Article ex./Artikelnr ex.: FORON256

Suspension lug nuts subal/ Befestigungsösen subal

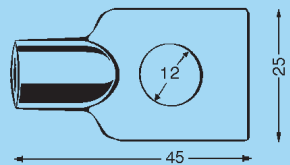

Zincpl/verz

Designation/ Bezeichnung	Inside thread/ Innengewinde	Box quantity/ Verpackung	Price/Preis €/1000 pcs/St
BO 25/6	M6	100	2925
BO 25/8	M8	100	2993
BO 25/10	M10	100	3225

Order ex./Best. ex: Suspension lug nuts subal/Befestigungsösen subal BO 25/6 M6
Article ex./Artikelnr ex.: FORONSUBAL256

Suspension lug nuts aducerad/ Befestigungsösen aducerad

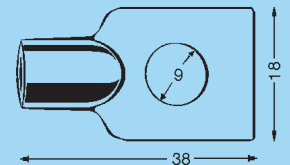

Zincpl/verz

Designation/ Bezeichnung	Inside thread/ Innengewinde	Box quantity/ Verpackung	Price/Preis €/1000 pcs/St
BO 18/6	M6	100	2063
BO 18/8	M8	100	2093

Order ex./Best. ex: Suspension lug nuts aducerad/Befestigungsösen aducerad BO 18/6 M6
Article ex./Artikelnr ex.: FORON186

Suspension lug nuts subal/ Befestigungsösen subal

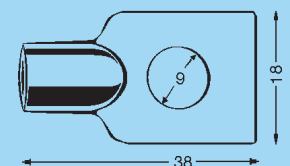

Zincpl/verz

Designation/ Bezeichnung	Inside thread/ Innengewinde	Box quantity/ Verpackung	Price/Preis €/1000 pcs/St
BO 18/6	M6	100	1793
BO 18/8	M8	100	1838

Order ex./Best. ex: Suspension lug nuts subal/Befestigungsösen subal BO 18/6 M6
Article ex./Artikelnr ex.: FORONSUBAL186

Rubber expander/ Gummi expander

WELL NUT®

Neoprene rubber/Neoprengummi

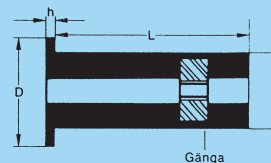

Thread/ Gewinde	Type/ Form	Grip area/ Greiffgebiet	d	D	L	h	Article no/ Artikel Nr	Box quantity/ Verp.	Price/Preis €/1000 pcs/St.
M3	C-632	9,5-15,4	6,1	14,1	24,0	0,9	WELLNUTC632	250	1716
M4	B-832	0,4-3,9	7,9	11,1	11,4	0,7	WELLNUTB832	250	1768
M5	A-1024	0,4-1,3	9,6	14,3	11,1	3,2	WELLNUTA1024	250	1898
M5	10-S	0,4-4,9	9,6	12,7	13,2	0,9	WELLNUT10S	250	1937
M5	Q-1032	0,9-5,9	9,6	14,3	15,9	1,0	WELLNUTQ1032	250	2015
M6	D-1420	0,8-4,7	12,7	18,8	16,3	4,8	WELLNUTD1420	250	2431
M8	E-51618	0,4-4,7	15,7	22,2	15,2	3,2	WELLNUTE51618	250	4433

Order ex./Best. ex: WELL NUT M3 Grip/greiff 9,5-15,4
Article ex./Artikelnr ex.: WELLNUTC632

General: Rubber expander used for applications with machine screw.
Fits materials up to 16,3 mm thickness, even for bottom holes.
A safe and tight adjustment which reduces vibration and noise.

Execution: Plain head. Vulcanized nut in the other end.

Material: Neoprene rubber. Nut consists of brass.

At request: Nitrile rubber.. UNC/UNF-thread.

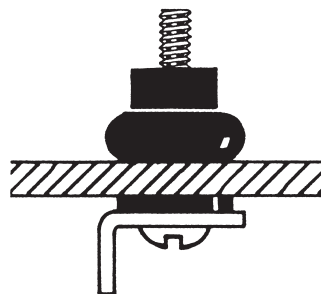

Rubber expander/ Gummi expander

BUFFEX

Neoprene/brass

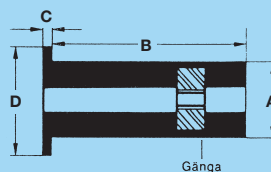

Thread/ Gewinde	Type/ Form	Grip area/ Greiffgebiet	d	D	L	h	Article no/ Artikel Nr	Box quantity/ Verp.	Price/Preis €/1000 pcs/St.
M3	JF-310	0,4-4,0	7,9	12,6	1,40	11,0	BUFFEX310	250	600
M4	JF-410	0,4-4,0	7,9	12,6	1,40	11,0	BUFFEX410	250	600
M5	JF-515	0,4-4,9	9,6	14,1	0,90	12,7	BUFFEX515	250	675
M5	JF-520	4,0-11,6	9,6	21,5	0,90	14,0	BUFFEX520	250	705
M5	JF-525	7,9-16	9,6	26,1	1,30	14,0	BUFFEX525	250	780
M5	JF-540	20,5-30	9,6	39,8	1,30	14,0	BUFFEX540	250	900
M6	JF-615	0,4-2,8	12,7	16,0	1,30	16,0	BUFFEX615	250	975
M6	JF-620	0,8-4,7	12,7	21,1	4,75	17,5	BUFFEX620	250	1100
M6	JF-625	6,4-11,5	12,7	26,7	2,00	16,3	BUFFEX625	250	1100
M8	JF-820	0,4-4,0	15,9	18,3	3,20	22,1	BUFFEX820	250	1350
M8	JF-825	3,95-9,5	15,9	27,93	5,72	22,1	BUFFEX825	250	1425

Order ex./Best. ex: M3 Grip/greiff 0,4-4,0 Neoprene/ brass
Article ex./Artikelnr ex.: BUFFEX310

Slotted spring plungers/ Federnde Druckstücke

With ball/mit Kugel
Steel/Stahl

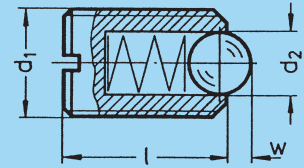

d ₁	d ₂	l	w	Article/ Artikel Nr	Box quantity/ Verpackung	Price/Preis €/1000 pcs/St.
M3	1,5	7	0,5	KULGN61503	100	7700
M4	2,5	9	0,8	KULGN61504	100	6100
M5	3	12	0,9	KULGN61505	100	6100
M6	3,5	14	1	KULGN61506	100	6100
M8	5	16	1,5	KULGN61508	100	8500
M10	6	19	2	KULGN61510	100	9300
M12	8	22	2,5	KULGN61512	100	13600
M16	10	24	3,5	KULGN61516	50	18900
M20	12	30	4,5	KULGN61520	25	29300
M24	15	34	5,5	KULGN61524	25	51600

Order ex./Best. ex: Slotted spring plungers/Federnde Druckstücke M3 With ball/mit Kugel
Article ex./Artikelnr ex.: KULGN61503

In addition to above – you also find following standard types/Zusätzlich zu den oben aufgeführten Artikeln sind folgende Standardausführungen erhältlich.

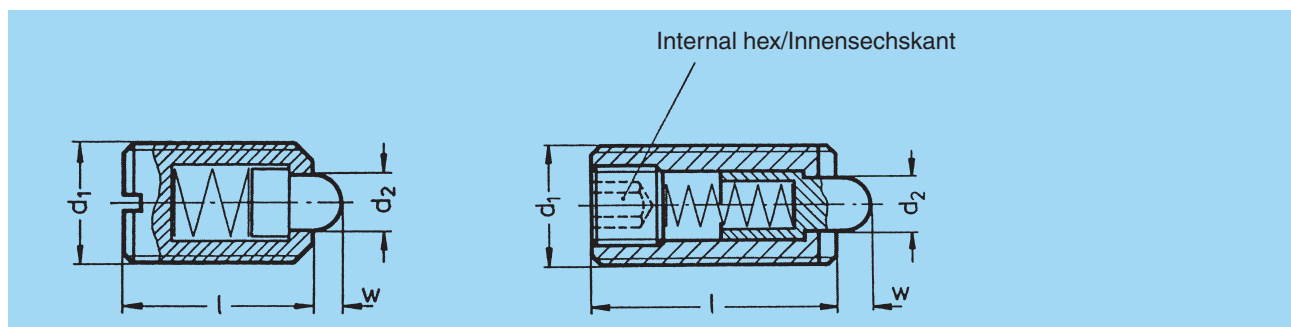

Single – head jaw wrench/ Einmaulschlüssel

DIN 894 DIN 895

Single double/einfach doppelt

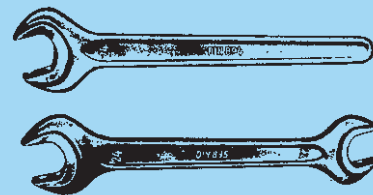

Single/ einfach	Box quantity/ Verpackung	Price/Preis €/1000 pcs/St.	Double/ doppelt	Box quantity/ Verpackung	Price/Preis €/1000 pcs/St.
NV 6	10	6750	NV 6 x 7	10	6750
NV 7	10	6300	NV 7 x 8	10	9450
NV 8	10	6300	NV 8 x 9	10	7425
NV 9	10	6750	NV 8 x 10	10	7425
NV 10	10	6750	NV 10 x 11	10	8100
NV 11	10	7200	NV 10 x 12	10	9900
NV 12	10	8100	NV 10 x 13	10	8100
NV 13	10	8100	NV 11 x 13	10	8325
NV 14	10	8325	NV 12 x 14	10	9450
NV 15	10	10350	NV 13 x 14	10	11700
NV 16	10	10350	NV 13 x 15	10	10350
NV 17	10	8550	NV 13 x 17	10	10350
NV 19	10	10800	NV 14 x 15	10	11700
NV 22	10	12600	NV 14 x 17	10	10350
NV 24	10	16650	NV 16 x 17	10	12150
NV 27	10	19350	NV 17 x 19	10	12150
NV 30	10	35100	NV 18 x 19	10	18000
NV 32	10	25650	NV 19 x 22	10	14850
NV 36	1	36000	NV 19 x 24	10	18000
NV 41	1	42975	NV 20 x 22	10	17100
NV 46	1	55800	NV 21 x 23	10	19350
NV 50	1	73800	NV 22 x 24	10	18450
NV 55	1	85500	NV 22 x 27	10	22050
NV 60	1	108000	NV 24 x 27	10	23400
NV 65	1	130500	NV 24 x 30	10	25650
NV 70	1	175500	NV 27 x 32	10	31950
NV 75	1	225000	NV 30 x 32	10	31950
NV 80	1	279000	NV 30 x 36	1	43200
NV 85	1	346500	NV 32 x 36	1	43200
NV 90	1	436500	NV 36 x 41	1	63900
NV 95	1	444000	NV 41 x 46	1	77400
NV 100	1	480000	NV 46 x 50	1	103500
NV 105	1	705000	NV 50 x 55	1	125000
NV 110	1	622500	NV 55 x 60	1	148500
NV 115	1	735000	NV 65 x 70	1	292500
			NV 75 x 80	1	336000

Order ex./Best. ex: Single-head jaw wrench/Einmaul Schlüssel NV 6

Article ex./Artikelnr ex.: 894006

Bits

Sockets for drill screws and bits
Hülse für Bohrschrauben und Bits

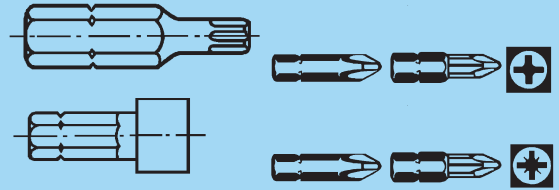

TX-BITS			PHILLIPSBITS		
Length/ Länge	Price/Preis €/1000 pcs/St.		Point/Spitze	Length/ Länge	Preis €/1000 pcs/St.
T 10	25	9225	1	25	2100
T 20	25	9225	2	25	2100
T 25	25	9225	3	25	2100
T 30	25	9225	4	25	7350
T 40	25	9225			
Order ex./Best. ex: BITS TX T10 Article ex./Artikelnr ex.: BITST10			Order ex./Best. ex: PHILLIPSBITS NR 1 Article ex./Artikelnr ex.: BITSH1		
Magnetic socket for drilling screws and bits/ Magnetische Hülse für Bohrschrauben und Bits			POZIDRIVEBITS		
NV	Length/ Länge	Price/Preis €/1000 pcs/St.	Point/ Spitz	Length/ Länge	Price/Preis €/1000 pcs/St.
5,5	25	14175	1	25	3150
6,0	25	14175	2	25	3150
7	25	14175	3	25	3150
8	25	14288	4	25	7350
10	25	14400			
1/4	25	14175			
3/8	25	14625			
Order ex./Best. ex: Magnetic socket/Magnetische Hülse 5,5 Article ex./Artikelnr ex.: MAGNETHYLSA055			Order ex./Best. ex: POZIDRIVESBITS NR 1 Article ex./Artikelnr ex.: BITSZ1		

Tool clips – closed type/ Stahlhalter geschlossen

Spring steel/Federstahl
Zincpl/verz

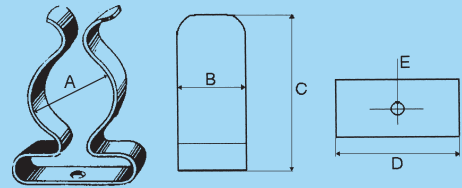

Article/ Artikelnr	Working range/ Klemmbereich mm	A= Innerdiam/ Innerdurchm	B= Breathth/ Breiten	C= Height/ Höhe	D= Breathth bottom/ Befestigungs- fläche	E= Holediam/ Loch- durchm	Box quantity/ Verp	Price/Preis €/1000 pcs/St
TCC 061	6-7	6	6,35	15,3	12,9	2,4	1000	300
TCC 101	10-12	10	6,35	20,0	15,5	2,4	1000	314
TCC 131	13-14	13	7,94	26,4	20,1	3,2	1000	422
TCC 161	16-19	16	7,94	32,2	22,6	3,2	1000	536
TCC 191	19-21	19	7,94	36,4	25,3	3,2	1000	588
TCC 251	25-27	25	9,52	40,3	28,8	3,2	500	689
TCC 281	28-31	28	9,52	48,7	34,1	3,6	500	1085
TCC 321	32-34	32	11,11	59,3	42,8	3,6	100	1296
TCC 381	38-40	38	12,7	67,0	49,5	*4,0	100	1733
TCC 511	51-54	51	12,7	80,2	53,0	*4,0	100	2115

Order ex./Best. ex.: Tool clips/Stahlhalter Closed type/ 6 Zincpl/verz
Article ex./Artikelnr ex.: TCC061

*TCC 381 2 holes at 8,0 mm centres.
*TCC 511 2 holes at 12,7 mm centres.

Tool clips – open type/ Stahlhalter offen

Spring steel/Federstahl
Zincpl/Verz

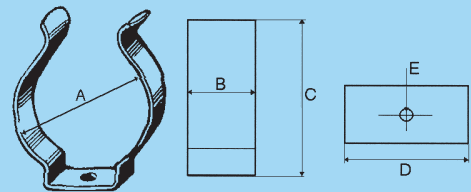

Article/ Artikelnr	Working range/ Klemmbereich mm	A= Innerdiam/ Innerdurchm	B= Breathth/ Breiten	C= Height/ Höhe	D= Breathth bottom/ Befestigungs- fläche	E= Holediam/ Loch- durchm	Box quantity/ Verp	Price/Preis €/1000 pcs/St
TCO 061	6-7	6	6,35	10,5	3,8	2,4	500	315
TCO 101	10-12	10	6,35	13,3	4,3	2,4	1000	329
TCO 131	13-14	13	7,94	16,1	5,0	2,4	500	417
TCO 161	16-19	16	7,94	20,5	6,5	2,4	1000	527
TCO 191	19-21	19	9,52	26,6	9,0	3,2	500	575
TCO 251	25-27	25	9,52	30,0	10,2	3,2	500	608
TCO 281	28-31	28	11,11	33,4	12,0	3,6	500	788
TCO 321	32-34	32	11,11	39,0	12,0	3,2	300	833
TCO 381	38-40	38	12,7	48,0	13,0	3,2	100	1205
TCO 511	51-54	51	12,7	61,3	19,5	*3,6	100	1485

Order ex./Best. ex.: Tool clips/Stahlhalter Closed type/ 6 Zincpl/verz
Article ex./Artikelnr ex.: TCO061

*TCO 511 2 holes at 9,5 mm centres.

Both types are available with polyethylene surface treatment/Beide Halter können auch mit Polyten belegt werden. Color: black or white/Farbe: schwarz oder weiß.
Send an enquiry for prices/Preis auf Anfrage

Box assortment/Sortimentskiste



Metal/Bleek

Content/Inhalt	Our article/ Unser Artikel	Price/Preis €/10 pcs/St
Fiber washers/Fiberscheiben DIN 7980, 18-Box/Kiste 1225 pcs/St.	S002	5400
Spring washers, plain washers, penny washers, 18-Box/Kiste 2115 pcs/St.	S004	3690
Lubr. nipple/Schmiernippel, 18-Box/Kiste 547 pcs/St.	S011	9990
Lubr. nipple/Schmiernippel, 18-Box/Kiste 274 pcs/St.	S011B	5963
DIN 125 Dopfer/Kupfer, 18-Box/Kiste 450 pcs/St.	S015	5079
SGA DIN 471, DIN 472, SGH, 18-Box/Kiste 140 pcs/St.	S018	4395
Star washers, 18-Box/Kiste 1225 pcs/St.	S020	4244
DIN 7971 C, 7973 C, 18-Box/Kiste 1425 pcs/St.	S021	3973
DIN 7971 CSS, 18-Box/Kiste 700 pcs/St.	S025	3599
Polyamide screw incl. nut and washer, 18-Box/Kiste 660 pcs/St.	S029	6590
DIN 83 incl. nut, 18-Box/Kiste 1800 pcs/St.	S030	3778
SPÅRSKRUV MRX, 18-Box/Kiste 1800 pcs/St.	S032	4411
DIN 471, 472, 12-Box/Kiste 160 pcs/St.	S033	4924
Hex cap screw/Sechskantschraube UNC Zincpl/verz, incl/inkl nuts/Muttern 12-Box/Kiste 420 pcs/St.	S037	5641
Hex cap screw/Sechskantschraube UNF Zincpl/verz, incl/inkl nuts/Muttern, 12-Box/Kiste 415 pcs/St.	S038	6979
Hex cap screw/Sechskantschraube Zincpl/verz, 18-Box/Kiste 530 pcs/St.	S043	4481
Hex cap screw/Sechskantschraube Zincpl/verz, 12-Box/Kiste 370 pcs/St.	S044	4258
Penny washers, 12-Box/Kiste 690 pcs/St.	S049	4482
DIN 7976-C, 12-Box/Kiste 600 pcs/St.	S054	4774
Plate screw washers, 12-Box/Kiste 1100 pcs/St.	S055	8348
Spring cotter/Federstecker, 18-Box/Kiste 375 pcs/St.	S057	3944
Woodruff keys, 18-Box/Kiste 135 pcs/St.	S058	5190
DIN 6799, 12-Box/Kiste 270 pcs/St.	S059	3986
DIN 137A, 12-Box/Kiste 1370 pcs/St.	S061	4538
Order ex./Best. ex: Box assortment/Sortimentkiste Fiber washers. 18-Box No. S002 Article ex./Artikelnr ex.: S002		
To get further information about the contents of the different boxes, please contact our salesdepartment/Für weitere Informationen über den Inhalt kontaktieren Sie uns.		

Box assortment/Sortimentskiste



Metal/Bleck

Content/Inhalt	Our article/ Unser Artikel	Price/Preis €/10 pcs/St
DIN 125 alum, 12-Box/Kiste 600 pcs/St.	S063	3997
Shim rings, 18-Box/Kiste 540 pcs/St.	S065	5385
DIN 7981, 7983, KFXS, 18-Box/Kiste 1300 pcs/St.	S066	3985
DIN 7981, 18-Box/Kiste 900 pcs/St.	S067	3864
DIN 7983 inkl. förs. bricka, 18-Box/Kiste 1100 pcs/St.	S068	4592
Speed nut/Schnappmutter SFP, SNP, 18-Box/Kiste 355 pcs/St.	S071	4438
O-rings/Ringen (AM.STANDARD), 18-Box/Kiste 450 pcs/St.	S074	3722
O-rings/Ringen (SVENSK STANDARD), 18-Box/Kiste 450 pcs/St.	S075	3646
Hexagen socket head cap screw/zynderschrauben mit innensechskant mm, 18-Box/Kiste 350 pcs/St.	S078	5087
Hexagen socket head cap screw/zynderschrauben mit innensechskant UNC, 12-Box/Kiste 200 pcs/St.	S079	6449
Slotted screw incl. nut, 18-Box/Kiste 1740 pcs/St.	S083	4279
POINT MONEL, 12-Box/Kiste 1002 pcs/St.	S084	7767
Nylon washers, 12-Box/Kiste 267 pcs/St.	S086	5371
DIN 976 A, 12-Box/Kiste 120 pcs/St.	S089	5610
Flat keys, 12-Box/Kiste 100 pcs/St.	S090	4420
Parallel pins, 12-Box/Kiste 255 pcs/St.	S091	4885
Conical pins, 18-Box/Kiste 245 pcs/St.	S092	5712
Blind rivets (alu.), 12-Box/Kiste 1002 pcs/St.	S093	5365
Blind rivets (alu.), 20-Box/Kiste 500 detalje	*S093B	3173
O-rings/Ringen(SVENSK STANDARD), 18-Box/Kiste 900 pcs/St.	S094	4050
Set screw mm, 18-Box/Kiste 135 pcs/St.	S095	3860
Set screw UNC, 12-Box/Kiste 100 pcs/St.	S096	5245
DIN 125, 12-Box/Kiste 1060 pcs/St.	S097	3986
Plastic washers, 18-Box/Kiste 445 pcs/St.	S099	3944
Bonded seal, 20-Box/Kiste 150 pcs/St.	S100	5775
DIN 94, 12-Box/Kiste 780 pcs/St.	S101	4122
Starlock lockwashers, 12-Box/Kiste 950 pcs/St.	S103	5130
VIKBRICKA, DIN 93, 12-Box/Kiste 315 pcs/St.	S105	5635
Pillar bolt, 12-Box/Kiste 72 pcs/St.	S106	7403
ROSTFRIA SAXPINNAR, 12-Box/Kiste 800 pcs/St.	S107	10705
DIN 94, 18-Box/Kiste 3350 pcs/St.	S109	4940
PLÅTSKRUV SVART RXS & KFXS, 18-Box/Kiste 825 pcs/St.	S111	5295
SJÄLVBORRANDE PLÅTSKRUV RXB & HB, 18-Box/Kiste 650 pcs/St.	S112	5420
ROSTFRI PLÅTSKRUV RXS & KFXS, 18-Box/Kiste 600 pcs/St.	S120	7306
ROSTFRI M-BULT + MUTTER & BRICKOR, 18-Box/Kiste 190 pcs/St.	S122	5657
ROSTFRI SPÅRSKRUV + MUTTER & BRICKOR, 18-Box/Kiste 380 pcs/St.	S126	5670
<p>Order ex./Best. ex: Box assortment/Sortimentkiste alu. washers. 12-Box No. S063</p> <p>Article ex./Artikelnr ex.: S063</p>		

To get further information about the contents of the different boxes, please contact our salesdepartment /Für weitere Informationen über den Inhalt kontaktieren Sie uns.

Box assortment/Sortimentskiste



Plastic/Kunststoff

Content/Inhalt	Our article/ unser Artikel	Price/Preis €/10 pcs/St
*DIN 933/931, 15-Box/Kiste 195 pcs/St.	SP40621	2040
*Slotted screw MCS incl. nut, 15-Box/Kiste 540 pcs/St.	SP41811	1200
*DIN 7981 C, 7983 C, 7976 C, 15-Box/Kiste 365 pcs/St.	SP42215	2070
*DIN 7971 C, 15-Box/Kiste 590 pcs/St.	SP42223	1530
*DIN 6798 A, 6798 J, 18-Box/Kiste 940 pcs/St.	SP43031	1980

Order ex./Best. ex: Box assortment/Sortimentkiste DIN 933/931

Article ex./Artikelnr ex.: SP40611

* Outgoing items/Außlaufender Artikeln

To get further information about the contents of the different boxes, please contact our salesdepartment /Für weitere Informationen über den Inhalt kontaktieren Sie uns.